



POWER

DRY CELL X

RECHARGEABLE X

120 VOLT X



DROP LIGHTS



POWER STATIONS



HEADLAMPS



WORK LIGHTS



FLASHLIGHTS



FIREPOINT X PROGRAM

FLASHLIGHTS

HEADLAMPS

PEN LIGHTS

WORK LIGHTS

FIREPOINT

BATTERIES INCLUDED

USES AA OR AAA BATTERIES

- ▶ High output light in a compact design
- ▶ Adjustable light beam, from spot to flood
- ▶ Anodized tactical aluminum housing
- ▶ Water and impact resistant

100+ LUMENS



1700+ LUMENS

ANODIZED TACTICAL ALUMINUM HOUSING

ADJUSTABLE FOCUS BEAM

NON ROLL IMPACT RESISTANT COLLAR

COOLING GROOVES
20% Better Efficiency

SUPER BRIGHT LED
Never needs replacing



FirePoint X flashlights feature a heavy duty design with improved thermal efficiency resulting in up to 20% better performance than comparable flashlights.



**1700+ LUMEN
FIREPOINT X
FLASHLIGHT**

Requires 9AA
batteries (included).

W2654

**1250+ LUMEN
FIREPOINT X
FLASHLIGHT**

Requires 6AA
batteries (included).

W2653

1700+
LUMENS



W2654

1250+
LUMENS



W2653

SPECIFICATIONS

LUMENS	RUNTIME	BATTERY TYPE	LENGTH
HIGH / LOW	HIGH / LOW		
1740 / 499	5 HR. / 8 HR.	9 x AA	245mm
1291 / 418	7 HR. / 10 HR.	6 x AA	197mm



**BATTERIES
INCLUDED**

Model	Description	Inner/Master	PKG	Display	UPC
W2654	FIREPOINT X 1700+LM FLASHLIGHT	6/24	CRD	No	039564128806
W2653	FIREPOINT X 1200LM FLASHLIGHT	6/24	CRD	No	039564128790

500+ LUMEN FIREPOINT X FLASHLIGHT

Requires 4AAA
batteries (included).

W2652

400+ LUMEN FIREPOINT X FLASHLIGHT

Requires 2AA
batteries (included).

W2651

500+
LUMENS



W2652

400+
LUMENS



W2651

SPECIFICATIONS

LUMENS	RUNTIME	BATTERY TYPE	LENGTH
HIGH / LOW	HIGH / LOW		
538 / 162	4 HR. / 8 HR.	4 x AAA	139mm
407 / 139	2 HR. / 4 HR.	2 x AA	168mm



**BATTERIES
INCLUDED**

Model	Description	Inner/Master	PKG	Display	UPC
W2652	FIREPOINT X 500LM FLASHLIGHT	6/24	CRD	No	039564012877
W2651	FIREPOINT X 470LM FLASHLIGHT	6/24	CRD	No	039564128783

**200+ LUMEN
FIREPOINT X
FLASHLIGHT**

Requires 1AA
battery (included).

W2649

**100+ LUMEN
FIREPOINT X
FLASHLIGHT**

Requires 3AAA
batteries (included).

W2656

200+
LUMENS

FIREPOINT X

100+
LUMENS



W2656



W2649



SPECIFICATIONS

LUMENS	RUNTIME	BATTERY TYPE	LENGTH
HIGH	HIGH		
210	3 HR.	1 x AA	110mm
108	4.5 HR.	3 x AAA	120mm



**BATTERIES
INCLUDED**

Model	Description	Inner/Master	PKG	Display	UPC
W2649	FIREPOINT X 210LM FLASHLIGHT	6/24	CRD	No	039564130816
W2656	FIREPOINT X 100LM FLASHLIGHT	12/48	BLK	Yes	039564128820

**300+ LUMEN
2-PK FLASHLIGHTS
W/ POUCH**

Operates on 3AAA batteries or 18650 li-ion battery (sold separately).

W2671



**300+
LUMENS**



SPECIFICATIONS

LUMENS	RUNTIME	BATTERY TYPE	LENGTH
HIGH / LOW	HIGH / LOW		
302 / 81	2.25 HR. / 15 HR.	3 x AAA / 18650 Li-ion	124mm

DUAL POWER

DRY CELL / LI-ION
3 AAA batteries / or 18650 battery

BATTERIES NOT INCLUDED

Model	Description	Inner/Master	PKG	Display	UPC
W2671	2-PK 300LM FLASHLIGHTS W/ POUCH	1/20	CBX	No	039564014222

**325+ LUMEN
FIREPOINT X
PEN LIGHT**

Requires 3AAA
batteries (included).

W2657

**243+ LUMEN
FIREPOINT LED
PEN LIGHT**

Requires 3AAA
batteries (included).

W2338

FIREPOINT X

**243+
LUMENS**

**325+
LUMENS**



W2338

SPECIFICATIONS

LUMENS	RUNTIME	BATTERY TYPE	LENGTH
HIGH / LOW	HIGH / LOW		
349 / 98	3 HR. / 5 HR.	3 x AAA	165mm
243	2.5 HR.	3 x AAA	168mm

**BATTERIES
INCLUDED**

Model	Description	Inner/Master	PKG	Display	UPC
W2657	FIREPOINT X 300LM PEN LIGHT	6/24	CRD	No	039564128837
W2338	FIREPOINT LED 243 LM PEN LIGHT	12/72	CRD	No	039564130663

ULTRA VIOLET FIREPOINT X FLASHLIGHT

365-395nm UV light. Requires
2AA batteries (included).

W2648

ULTRA VIOLET FIREPOINT PEN LIGHT

Requires 3AAA
batteries (included).

W2329



W2648



W2329



SPECIFICATIONS

nanometer	RUNTIME	BATTERY TYPE	LENGTH
	HIGH		
365-395 NM	2 HR.	2 x AA	168mm
365 NM	10 HR.	3 x AAA	168mm

**UV
LED**

**BATTERIES
INCLUDED**

Model	Description	Inner/Master	PKG	Display	UPC
W2648	FIREPOINT X UV FLASHLIGHT	6/24	CRD	No	039564135491
W2329	FIREPOINT UV LED PEN LIGHT	12/72	CRD	No	039564013843

**450+ LUMEN
FIREPOINT X
POCKET LIGHT**

High strength magnetic base.
Requires 3AA batteries (included).

W2331

**80 LUMEN
POCKET TECH LIGHT**

Powered by 1AAA battery (included).

W2332

**450+
LUMENS**

FIREPOINT X



**80
LUMENS***



W2331



W2332



Doubles as Stylus

SPECIFICATIONS

LUMENS	RUNTIME	BATTERY TYPE	LENGTH
HIGH / LOW	HIGH		
452 / 150	2 HR.	3 x AA	190mm
80 / 60	2 HR.	3 x AAA	140mm

**BATTERIES
INCLUDED**

Model	Description	Inner/Master	PKG	Display	UPC
W2331	FIREPOINT 450+ LM POCKET LIGHT	6/24	CRD	No	039564126550
W2332	80 LM POCKET TECH LIGHT	6/24	CRD	No	039564138911

**200 LUMEN
COB WORK LIGHT**

Powered by 3AAA
batteries (included).

W2326



Emergency Red Flasher

**200
LUMENS**



SPECIFICATIONS

LUMENS	RUNTIME	BATTERY TYPE
HIGH / LOW	HIGH / LOW	
200 / RED	2.5 HR. / 48 HR.	3 x AAA

Model	Description	Inner/Master	PKG	Display	UPC
W2326	200 LM COB WORKLIGHT	6/24	CRD	No	039564138898

**500+ LUMEN
FOLDING THIN
WORK LIGHT**

Powered by 3AA
batteries (included).

FIREPOINT X

W2418



SPECIFICATIONS		
LUMENS	RUNTIME	BATTERY TYPE
HIGH / LOW	HIGH / LOW	
509 / 240	1 HR. / 2.5 HR.	3 x AA



**500+
LUMENS**

**BATTERIES
INCLUDED**

Model	Description	Inner/Master	PKG	Display	UPC
W2418	500+LM FOLDING THIN WORK LIGHT	5/20	CRD	No	039564145896

180 LUMEN LED HEADLAMP

Powered by 3AAA batteries (included).

W2334



W2334

180 LUMENS

FIREPOINT X



150+ LUMEN 2-PK MINI LED HEADLAMPS

Powered by 3AAA batteries each (included).

W2328



W2328

150+ LUMENS



SPECIFICATIONS

LUMENS	RUNTIME	BATTERY TYPE
HIGH / LOW	HIGH / LOW	
180 / 55	5 HR. / 16 HR.	3 x AAA
156 / 41	6 HR. / 16 HR.	3 x AAA (Each)

BATTERIES INCLUDED

Model	Description	Inner/Master	PKG	Display	UPC
W2334	180LM LED HEADLAMP	6/24	CRD	No	039564130694
W2328	2-PK MINI 150LM HEADLAMPS	8/64	CRD	Yes	039564014321

FIREPOINT

RECHARGEABLE

RECHARGEABLE
Li-ion
BATTERY

- ▶ High output light in a compact design
- ▶ Adjustable light beam, from spot to flood
- ▶ Anodized tactical aluminum housing
- ▶ Water and impact resistant

100+
LUMENS



4000+
LUMENS

ANODIZED TACTICAL ALUMINUM HOUSING

ADJUSTABLE FOCUS BEAM

NON ROLL IMPACT RESISTANT COLLAR

COOLING GROOVES
20% Better Efficiency

SUPER BRIGHT LED
Never needs replacing



USB
CHARGED

SPOT TO FLOOD

FirePoint X flashlights feature a heavy duty design with improved thermal efficiency resulting in up to 20% better performance than comparable flashlights.

4000+ LUMEN FIREPOINT X LI-ION FLASHLIGHT

Includes USB battery
charger and (2) 26650 Li-ion
batteries: 3.7V, 3400mAh
capacity, 12.58 watt hours.



4000+
LUMENS

3000+
LUMENS

W2669

3000+ LUMEN FIREPOINT X LI-ION FLASHLIGHT

Includes (2) 2600mAh, 3.7V
Li-ion batteries. Includes USB
battery charger.

W2655



W2669



W2655

SPECIFICATIONS

LUMENS	RUNTIME	BATTERY TYPE	LENGTH
HIGH / LOW	HIGH / LOW		
4026 / 480	4.5 HR. / 12.5 HR.	2 x 26650 Li-ion	215mm
3061 / 754	3 HR. / 6 HR.	2 x 18650 Li-ion	208mm



Model	Description	Inner/Master	PKG	Display	UPC
W2669	FIREPOINT X 4000+LM LI-ION FLASHLIGHT	6/24	CRD	No	039564134401
W2655	FIREPOINT X 3000+LM LI-ION FLASHLIGHT	6/24	CRD	No	039564128813

**1000+ LUMEN
FIREPOINT X LI-ION
FLASHLIGHT**

Requires (1) 18650 Li-ion battery (included) or 3AAA batteries (not included).

W2658

**500+ LUMEN
FIREPOINT X LI-ION
FLASHLIGHT**

Requires (1) 16340 Li-ion battery (included): 3.7V, 700mAh capacity, 2.59 watt hours.

W2659

1000+
LUMENS

500+
LUMENS



W2658



W2659

SPECIFICATIONS

LUMENS	RUNTIME	BATTERY TYPE	LENGTH
HIGH / LOW	HIGH / LOW		
1001 / 227	4 HR. / 6 HR.	18650 Li-ion	175mm
520 / 160	1 HR. / 2 HR.	16340 Li-ion	120mm



Model	Description	Inner/Master	PKG	Display	UPC
W2658	FIREPOINT X 1000+LM LI-ION FLASHLIGHT	6/24	CRD	No	039564132551
W2659	FIREPOINT X LI-ION 500+ LM FLASHLIGHT	6/24	CRD	No	039564135507

300+ LUMEN FIREPOINT X LI-ION FLASHLIGHT

Built-in 10440, 320mAh capacity,
li-ion battery (included).



W2661

W2663



W2661



W2663

300+
LUMENS

SPECIFICATIONS

LUMENS	RUNTIME	BATTERY TYPE	LENGTH
HIGH / LOW	HIGH / LOW		
316 / 100	0.5 HR. / 1.5 HR.	10440 Li-ion	103mm



Model	Description	Inner/Master	PKG	Display	UPC
W2661	FIREPOINT X 300+LM LI-ION FLASHLIGHT	8/32	BLK	Yes	039564135569
W2663	FIREPOINT X 300+LM LI-ION FLASHLIGHT	6/24	CRD	No	039564102561

**400+ LUMEN
FIREPOINT X USB
FLASHLIGHT**

Includes built-in 16340 Li-ion battery: 3.7V,
750mAh capacity, 2.78 watt hours.



W2668



400+
LUMENS



SPECIFICATIONS

LUMENS	RUNTIME	BATTERY TYPE	LENGTH
HIGH / LOW	HIGH / LOW		
418 / 108	1 HR. / 2 HR.	16340 Li-ion	124mm

Model	Description	Inner/Master	PKG	Display	UPC
W2668	FIREPOINT X 400+LM USB FLASHLIGHT	6/24	CRD	No	039564131189

**350+ LUMEN
FIREPOINT X LI-ION
PEN LIGHT**

Requires (1) 10850 Li-ion battery (included):
3.7V, 750mAh capacity, 2.78 watt hours.

W2667



**350+
LUMENS**



SPECIFICATIONS

LUMENS	RUNTIME	BATTERY TYPE	LENGTH
HIGH / LOW	HIGH / LOW		
368 / 101	3 HR. / 5.5 HR.	10870 Li-ion	190mm

Model	Description	Inner/Master	PKG	Display	UPC
W2667	FIREPOINT X 350+LM LI-ION PEN LIGHT	6/24	CRD	No	039564136696

**350+ LUMEN
FIREPOINT X LI-ION
DUO-LIGHT**

Built-in 14500, 600mAh capacity,
li-ion battery (included).

W2672

W2677

**350+
LUMENS**



W2672



W2677



SPECIFICATIONS

LUMENS	RUNTIME	BATTERY TYPE	LENGTH
HIGH / LOW	HIGH / LOW		
375 / 100	1.5 HR. / 4 HR.	14500 Li-ion	100mm



Model	Description	Inner/Master	PKG	Display	UPC
W2672	FIREPOINT X 350+LM LI-ION DUO-LIGHT	8/32	BLK	Yes	039564143557
W2677	FIREPOINT X 350+LM LI-ION DUO-LIGHT	6/24	CRD	No	039564101236

200 LUMEN LI-ION BRIM CLIP LED LIGHT

Clips on to brim of hat for hands free use. Adjustable head for precise illumination. Internal rechargeable li-ion battery. Includes micro USB cord.



W2336



SPECIFICATIONS

LUMENS	RUNTIME	BATTERY TYPE
HIGH / LOW	HIGH / LOW	
200 / 60	1.5 HR. / 4 HR.	450 mAh Li-ion

**200
LUMENS**

RECHARGEABLE
**Li-ion
BATTERY**

Model	Description	Inner/Master	PKG	Display	UPC
W2336	LI-ION 200 LM BRIM CLIP LED LIGHT	12/72	CRD	No	039564130731

450+ LUMEN DUAL BEAM HEADLAMP

VARIABLE OUTPUT SYSTEM: dual 21+ 1 LED light sources, each with high/low output. Flexible operation features touch-free sensor mode.



W2676



450+
LUMENS



SPECIFICATIONS		
LUMENS	RUNTIME	BATTERY TYPE
HIGH / LOW	HIGH / LOW	
465 / 139	2.5 HR. / 3.5 HR.	1200 mAh Li-ion

Model	Description	Inner/Master	PKG	Display	UPC
W2676	450+LM DUAL BEAM HEADLAMP	10/60	CBX	No	039564116018

**300+ LUMEN
LI-ION 2-IN-1
HEADLAMP**

Produces a combined 300+ lumens - 210 lumen area light and 110 lumen spot light. Both sets of LEDs operate simultaneously or independently at 100% or 50%.



W2327



SPECIFICATIONS

LUMENS	RUNTIME	BATTERY TYPE
HIGH	HIGH	
320	2.5 HR.	18650 Li-ion

**300+
LUMENS**

RECHARGEABLE
**Li-ion
BATTERY**

Model	Description	Inner/Master	PKG	Display	UPC
W2327	300+LM LI-ION 2-IN-1 HEADLAMP	4/48	CBX	No	039564143274

500 LUMEN LOW PROFILE STRIP HEADLAMP

Uses professional grade licensed COB [Chip-on-Board] technology strips. Adjustable strap with rear battery pack with power level indicator.

W2681



FIREPOINT X



SPECIFICATIONS		
LUMENS	RUNTIME	BATTERY TYPE
HIGH / LOW	HIGH / LOW	
500 / 100	2.5 HR. / 10 HR.	1800 mAh Li-Poly

500 LUMENS

RECHARGEABLE
Li-ion BATTERY

Model	Description	Inner/Master	PKG	Display	UPC
W2681	500LM LOW PROFILE STRIP HEADLAMP	8/48	CRD	No	039564146909

**550 LUMEN
STRIP & SPOT
HEADLAMP**

Uses professional grade licensed COB [Chip-on-Board] technology strip. Adjustable strap with rear battery pack with power level indicator.

W2682



SPECIFICATIONS

LUMENS	RUNTIME	BATTERY TYPE
HIGH / LOW	HIGH / LOW	
550 / 100	2.5 HR. / 5 HR.	1800 mAh Li-Poly

**550
LUMENS**

**RECHARGEABLE
Li-ion
BATTERY**

Model	Description	Inner/Master	PKG	Display	UPC
W2682	550LM STRIP AND SPOT HEADLAMP	8/48	CRD	No	039564146916

2000+ LUMEN*
FIREPOINT X LI-ION
XL HEADLAMP



Features 3 output modes: turbo boost, high, and low. Includes 2600mAh 18650 rechargeable lithium ion battery and micro USB charging cable (use replacement battery W2655B).

W2664



2000+
LUMENS



**Boost mode produces over 2000 lumens and is designed to stay on for 60 seconds.*

SPECIFICATIONS

LUMENS	RUNTIME	BATTERY TYPE
HIGH / LOW	HIGH / LOW	
1500 / 250	2.5 HR. / 7 HR.	18650 Li-ion

Model	Description	Inner/Master	PKG	Display	UPC
W2664	FIREPOINT X 2000+LM LI-ION XL HEADLAMP	6/24	CRD	No	039564140792

600 LUMEN RECHARGEABLE HEADLAMP

Magnetic USB charge cable included.
Powered by (1) 16340 3.7V lithium ion
rechargeable battery (included).



W2647



SPECIFICATIONS

LUMENS	RUNTIME	BATTERY TYPE
HIGH / LOW	HIGH / LOW	
600 / 250	1.2 HR. / 2 HR.	16340 Li-ion

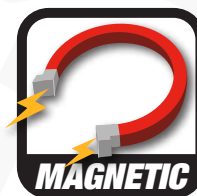

**600
LUMENS**



Model	Description	Inner/Master	PKG	Display	UPC
W2647	600 LM RECHARGEABLE HEADLAMP	8/48	CRD	No	039564138904

**1000+ LUMEN
FIREPOINT X LI-ION
HEADLAMP**

Requires 18650 rechargeable lithium ion battery (included).



W2660



SPECIFICATIONS

LUMENS	RUNTIME	BATTERY TYPE
HIGH / LOW	HIGH / LOW	
1043 / 151	4 HR. / 10 HR.	18650 Li-ion

1000+

LUMENS

RECHARGEABLE
Li-ion
BATTERY

Model	Description	Inner/Master	PKG	Display	UPC
W2660	FIREPOINT X 1000+LM LI-ION HEADLAMP	6/24	CRD	No	039564132766

30 LED SLIM WORK LIGHT

Thin, low profile light bar body for access in confined areas. Swivel hook and removable 360° swivel magnetic base for hands free use. Built-in rechargeable lithium ion 18650 battery and charging cable.

W2231



SPECIFICATIONS

LUMENS	RUNTIME	BATTERY TYPE
HIGH / LOW	HIGH / LOW	
600 / 150	2.5 HR. / 10 HR.	18650 Li-ion

600+
LUMENS

RECHARGEABLE
Li-ion
BATTERY

Model	Description	Inner/Master	PKG	Display	UPC
W2231	30 LED SLIM WORK LIGHT	1/50	CBX	No	039564131646

1200+ LUMEN FIREPOINT X LI-ION WORK LIGHT

Pivoting handle can be used as a stand or hanging/carrying and includes a snap-on hook. Wide angle LEDs distribute large flood beam of light. Battery indicator and 5V @ 2A input/output power, 4400mAh li-ion batteries.

W2234



FIREPOINT X

**1200+
LUMENS**



SPECIFICATIONS

LUMENS	RUNTIME	BATTERY TYPE
HIGH / LOW	HIGH / LOW	
1206 / 606	2 HR. / 4 HR.	4400 mAh Li-ion



Model	Description	Inner/Master	PKG	Display	UPC
W2234	FIREPOINT X 1200 LM LI-ION WORK LIGHT	6/24	CRD	No	039564136719

500+ LUMEN 3-IN-1 FIREPOINT X WORK LIGHT

Spot light features warm white for a more natural light and better color recognition. Magnetic swivel base for hands free use. Pocket clip with swivel hook for added utility. LED battery indicator with built-in rechargeable lithium ion 18650 battery and charging cable.

W2325



500+
LUMENS



SPECIFICATIONS

LUMENS	RUNTIME	BATTERY TYPE
HIGH	HIGH	
561	2.5 HR.	18650 Li-ion

Model	Description	Inner/Master	PKG	Display	UPC
W2325	FIREPOINT 3-IN-1 500+LM WORK LIGHT	6/48	CRD	No	039564138492

**800+ LUMEN
DOUBLE SIDED
LI-ION THIN LIGHT**

Built-in rechargeable lithium ion
18650 battery and charging cable.

FIREPOINT X



W2670

**Double Sided
Pivots 180°**



**800+
LUMENS**

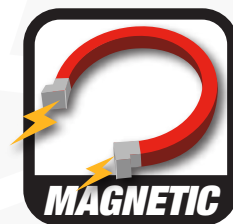

SPECIFICATIONS

LUMENS	RUNTIME	BATTERY TYPE
HIGH	HIGH	
814	2 HR.	18650 Li-ion

Model	Description	Inner/Master	PKG	Display	UPC
W2670	DOUBLE SIDED 800+LM LI-ION THIN LIGHT	6/24	CRD	No	039564136979

1000+ LUMEN LI-ION UNDERHOOD WORK LIGHT

Innovative design spans hoods over 6 feet wide. Adjustable elastic strap fits almost any size hood. Rubber padded hooks prevent scratching or denting. Powered by dual 18650 2200mAh Li-ion batteries (included) and USB charging cable.



W2673



SPECIFICATIONS		
LUMENS	RUNTIME	BATTERY TYPE
HIGH	HIGH	
1071	2.5 HR.	2 x 18650 Li-ion

1000
LUMENS

RECHARGEABLE
Li-ion
BATTERY

Model	Description	Inner/Master	PKG	Display	UPC
W2673	1000+LM LI-ION UNDERHOOD WORK LIGHT	1/20	CBX	No	039564014246

150+ LUMEN PIVOTING LED THIN WORK LIGHT

Double hinged light bar provides 360 degrees of light for precise illumination. Features additional light at the tip, magnetic base, swivel hook and pocket clip. Integrated 14500 lithium-ion rechargeable battery (USB cord included).



20237

W2646

20244



20244



W2646



20237



20237



20244



W2646

SPECIFICATIONS

LUMENS	RUNTIME	BATTERY TYPE
HIGH / LOW	HIGH / LOW	
150 / 70	2.5 HR. / 3.5 HR.	14500 Li-ion



Model	Description	Inner/Master	PKG	Display	UPC
20237	150+LM PIVOTING LED THIN WORK LIGHT	6/144	LAB	No	039564014284
W2646	150+LM PIVOTING LED THIN WORK LIGHT	12/72	CRD	No	039564144790
20244	150+LM PIVOTING LED THIN WORK LIGHT	6/144	LAB	No	039564147579

1200+ LUMEN LI-ION LED DROP LIGHT

Built-in lithium ion batteries provide cordless operation for up to two hours. Impact resistant handle with non-slip rubber grip and magnetic bracket. Powder coated metal lamp shield with swivel hang hook.



W2240



Due to continuing improvements, actual product may differ slightly from photo shown.



**USB
CHARGED**

SPECIFICATIONS

LUMENS	RUNTIME	BATTERY TYPE
HIGH 1200	HIGH 2 HR.	2 x 18650 Li-ion

1200+
LUMENS

RECHARGEABLE
Li-ion
BATTERY

Model	Description	Inner/Master	PKG	Display	UPC
W2240	1200+ LM LI-ION LED DROP LIGHT	4/16	LAB	No	039564100734

**300+ LUMEN
LI-ION COMPACT
WORK LIGHT**



Rare earth magnet on back for hands free work. Flip-up hook for added versatility.

W2675



SPECIFICATIONS		
LUMENS	RUNTIME	BATTERY TYPE
HIGH 320	HIGH 3 HR.	1000 mAh Li-ion

300+
LUMENS

RECHARGEABLE
Li-ion
BATTERY

Model	Description	Inner/Master	PKG	Display	UPC
W2675	300+LM LI-ION COMPACT WORK LIGHT	8/96	CRD	Yes	039564144820

1200 LUMEN* COMPACT FLASHLIGHT

Black anodized aluminum alloy steel construction with IPX4 water resistance. 4-Output Settings.

W2678



FIREPOINT X



2000 LUMEN* COMPACT FLASHLIGHT

Black anodized aluminum alloy steel construction with IPX4 water resistance. 4-Output Settings.

W2679



*W2678 - Boost mode produces over 1200 lumens and is designed to stay on for 20 seconds.

*W2679 - Boost mode produces over 2000 lumens and is designed to stay on for 20 seconds.

SPECIFICATIONS

LUMENS	RUNTIME	BATTERY TYPE
HIGH / LOW	HIGH / LOW	
600 / 300	2.5 HR. / 5.5 HR.	18350 Li-ion
1800 / 500	1 HR. / 3 HR.	18350 Li-ion

RECHARGEABLE
Li-ion
BATTERY

Model	Description	Inner/Master	PKG	Display	UPC
W2678	1200LM COMPACT FLASHLIGHT	8/48	CRD	No	039564146930
W2679	2000LM COMPACT FLASHLIGHT	8/48	CRD	No	039564146923

150 LUMEN LI-ION LIGHTED PEN

Built-in rechargeable li-ion battery provides an hour of runtime. Double ended pocket clip for storage or hands-free use.

W2674

2PK REPLACEMENT INK CARTRIDGES

Includes two refills to help extend the life of your W2674 LED pen

W2674-1

10280 LI-ION RECHARGEABLE BATTERY

Replacement li-ion battery for W2674B

W2674B



W2674



Doubles as Stylus

FIREPOINT X

150+
LUMENS



W2674-1



W2674B

SPECIFICATIONS

LUMENS	RUNTIME	BATTERY TYPE	LENGTH
HIGH	HIGH		
150	1 HR.	10280 LI-ION	165mm



Model	Description	Inner/Master	PKG	Display	UPC
W2674	150LM LI-ION LIGHTED PEN	6/48	CRD	No	039564014383
W2674-1	2PK REPLACEMENT INK CARTRIDGES	24/432	CRD	No	039564144790
W2674B	FIREPOINT X 350+LM LI-ION DUO-LIGHT	6/48	CRD	No	039564014475

LI-ION 18650 RECHARGEABLE BATTERY

Standard replacement 18650 cell with 2600mAh capacity. No memory effect - recharge up to 1200 times whether fully or partially drained.

W2655B



16340 LI-ION RECHARGEABLE BATTERY

Standard replacement 16340 cell with 700mAh capacity. No memory effect - recharge up to 500 times whether fully or partially drained.

W2659B



26650 LI-ION RECHARGEABLE BATTERY

Replacement 26650 cell with 4000mAh capacity. No memory effect - recharge up to 800 times whether fully or partially drained.

W2669B



Model	Description	Inner/Master	PKG	Display	UPC
W2655B	LI-ION 18650 RECHARGEABLE BATTERY	6/48	CRD	No	039564130717
W2659B	16340 LI-ION RECHARGE BATTERY	6/48	CRD	No	039564102967
W2669B	26650 LI-ION RECHARGE BATTERY	12/48	CRD	No	039564013805

DUAL 18650 BATTERY USB CHARGER

Home and travel charger for standard 18650 model lithium ion batteries. Specifications: Input voltage: DC 5V; Output voltage: 4.2V; Current: 650mA (x 2). Includes 39 inch (1M) micro USB cable.

W2655C



DUAL 26650 BATTERY USB CHARGER

Home and travel charger for standard 18650, 26650, 16340 and other model lithium ion batteries. Specifications: Input voltage: DC 5V (2A max); Output voltage: 4.2V; Current: 1A (x 2); Includes 31.5 inch (0.8M) micro USB cable.

W2669C



Model	Description	Inner/Master	PKG	Display	UPC
W2655C	DUAL 18650 BATTERY USB CHARGER	6/24	CRD	No	039564130724
W2669C	DUAL 26650 BATTERY USB CHARGER	6/24	CRD	No	039564013799

6500+ LUMEN 120V LED CEILING LIGHT

Energy efficient replacement to high output halogen, halide, sodium or other incandescent lights. Die cast cooling blades dissipate heat to provide optimal output. Specifications: input voltage AC85-265V 50-60Hz; CRI 80Ra; 3000K color temperature.



6500+
LUMENS

W2284



Lighting Facts

Brightness	6500 lumens
Estimated Yearly Energy Cost	\$6.59
Based on 3 hrs/day, 11¢/kWh Cost depends on rates and use	
Life	2 - 3 years
Based on 3 hrs/day	
Light Appearance	
<div style="display: flex; justify-content: space-between; align-items: center;"> Warm ————— ————— Cool </div> <div style="text-align: center; margin-top: 5px;"> ▲ 3000 K </div>	
Energy Used	55 watts

Model	Description	Inner/Master	PKG	Display	UPC
W2284	6500LM 120V LED CEILING LIGHT	1/18	CBX	No	039564131165

6500+ LUMEN 120V WORK LIGHT W/ TRIPOD STAND

Energy efficient replacement to high output halogen, halide, sodium or other incandescent lights. Fully adjustable tripod with a height range of 70-200cm (27.5-78.5") and standard 1/4"-20 threaded receiver. Specifications: input voltage AC85-265V 50-60Hz; CRI 80Ra; 3000K color temperature.

W2286

120V_{olt}



6500+ LUMENS

Extends to over 78 in. tall

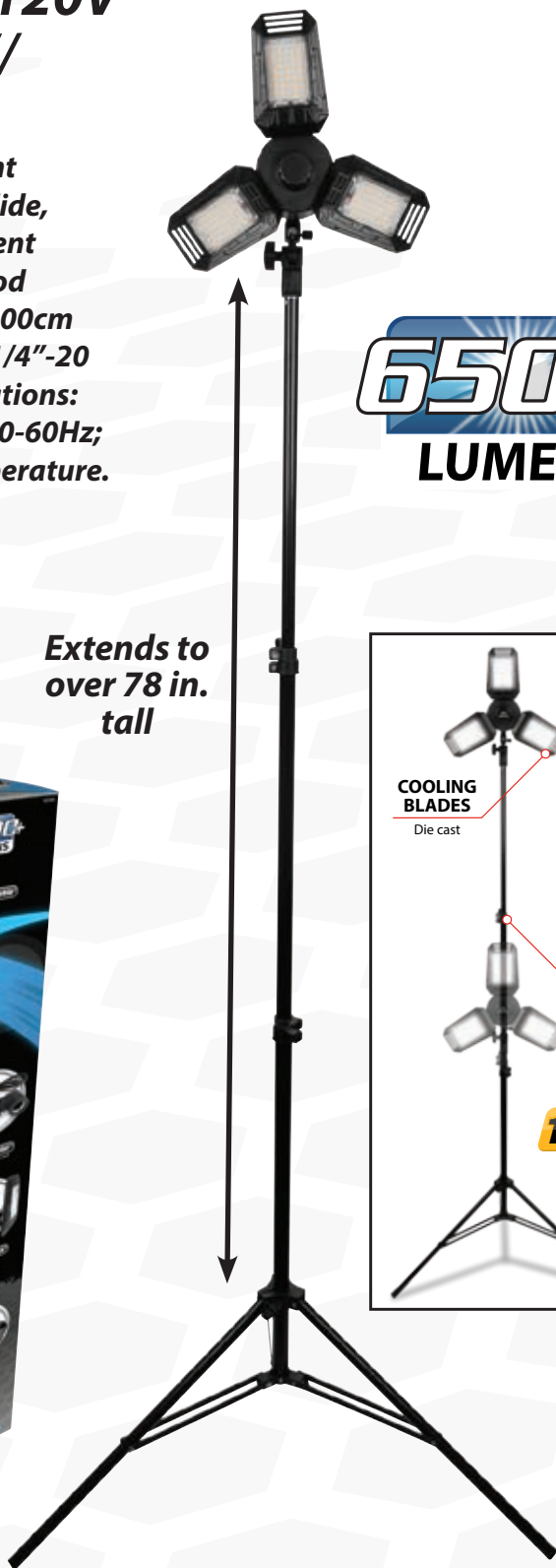

Model	Description	Inner/Master	PKG	Display	UPC
W2286	120V 6500LM WORK LIGHT W/TRIPOD STAND	1/4	CBX	No	039564136429

8-IN-1 MULTI-TAP OUTLET

8-in-1 power strip features 4 grounded 120-volt outlets 3 standard USB ports and 1 USB-C port. High quality construction features fire-retardant casing up to 1382° F (750° C), 5 ft. (1.5m), 14AWG braided copper power cord, and overload shut-off switch.



W2266



AC



USB



USB-C



Model	Description	Inner/Master	PKG	Display	UPC
W2266	8-IN-1 MULTI-TAP OUTLET	10/30	CBX	No	039564146831

1000 LUMEN 120V WORKBENCH POWER STATION

2 LED lights put out a total of 1000 lumens of 6000K daylight, illuminating your work area and pivot downward, up to 90 degrees, to focus light onto your workbench. 2x USB Charging ports provide 5v@2.4 amp on each (3.4A total max) with over current protection. 6 ft - 14/3 AWG cord has heavy rubber coating and grounded 3 prong plug for safety, durability, and long service life.

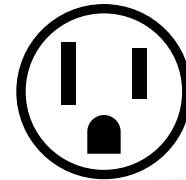

AC

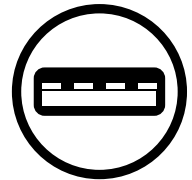

USB

W2279



1000
LUMENS

Model	Description	Inner/Master	PKG	Display	UPC
W2279	1000LM 120V WORKBENCH POWER STATION	1/4	CBX	No	039564144363

**1200 LUMEN
ROUGH SERVICE LED
LIGHT BULB 12W**

**1200+
LUMENS**

Equivalent to a 75W incandescent light bulb and fits most standard A19/E26 type sockets. Specifications: input voltage 110-250V AC; CRI 80Ra; 2700K color temperature; 50-60Hz; minimum lifetime of 3600 hours.

W2282

**1500 LUMEN
ROUGH SERVICE LED
LIGHT BULB 15W**

**1500+
LUMENS**

Equivalent to a 100W incandescent light bulb and fits most standard A19/E26 type sockets. Specifications: input voltage 110-265V AC; CRI 80Ra; 2700K color temperature; 50-60Hz; minimum lifetime of 3600 hours.

W2283

120V_{olt}



Lighting Facts Per Bulb	
Brightness	1200/1500 lumens
Estimated Yearly Energy Cost	\$1.97/ Based on 3 hrs/day, 15¢/kWh
	\$2.53 Cost depends on rates and use
Life	13 years Based on 3 hrs/day
Light Appearance	Warm ▲ Cool
	3000 K
Energy Used	12/15 watts

**ROUGH SERVICE
BULB**

Model	Description	Inner/Master	PKG	Display	UPC
W2282	1200LM LED LIGHT BULB 12W	10/50	CBX	No	039564135620
W2283	1500LM LED LIGHT BULB 15W	10/50	CBX	No	039564135637

1000+ LUMEN 120V LED DROP LIGHT

Impact resistant handle with non-slip rubber grip.
Powder coated metal lamp shield with swivel
hang hook. 25ft grounded cord with built-in 120V
outlet (500W MAX). US Patent D883560.

120V_{olt}

W2237



1000+
LUMENS

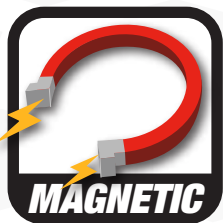

Model	Description	Inner/Master	PKG	Display	UPC
W2237	1000+LM 120V LED DROP LIGHT	4/16	LAB	No	039564126987

1600+ LUMEN 12V LED DROP LIGHT

Impact resistant handle with non-slip rubber grip and magnetic bracket. Powder coated metal lamp shield with fold down swivel hang hook. 20ft 22GA cord with 12V plug and battery clamp adapter. US Patent D883560.



W2238



MAGNETIC



USB port on the bottom of the handle to charge your phone, tablet or other device while you work.



**1600+
LUMENS**



Model	Description	Inner/Master	PKG	Display	UPC
W2238	1600+LM 12V LED DROP LIGHT	4/16	LAB	No	039564136702

120V STEEL CAGE PRO DROP LIGHT

Reflective galvanized metal lamp shield with swivel hang hook. Impact resistant handle with comfortable non-slip rubber grip. Standard E26 light socket uses up to 75 watt incandescent bulb or LED equivalent. 25ft grounded cord with built-in 120V outlet (500W MAX).

120v_{olt}

W2243



Designed for use with LED A19/ A26 style bulbs, Performance Tool Models W2282/W2283. US Patent D883560.

Model	Description	Inner/Master	PKG	Display	UPC
W2243	120V STEEL CAGE PRO DROP LIGHT	4/16	LAB	No	039564103070

BLUE 50FT 16GA EXTENSION CORD

All-weather indoor/outdoor extension cord features lighted outlet that readily indicates power available. High visibility blue coating resists moisture, abrasion, and UV sunlight. Cold weather-resistant materials are temperature rated to -58° F (-50° C). cETL listed 3126867.

W2256



Lighted End.



Model	Description	Inner/Master	PKG	Display	UPC
W2257	BLUE 50FT 16GA EXTENSION CORD	1/12	SLV	No	039564012303

BLUE 25FT 16GA EXTENSION CORD

All-weather indoor/outdoor extension cord features lighted outlet that readily indicates power available. High visibility blue coating resists moisture, abrasion, and UV sunlight. Cold weather-resistant materials are temperature rated to -58° F (-50° C). cETL listed 3126867.



W2256

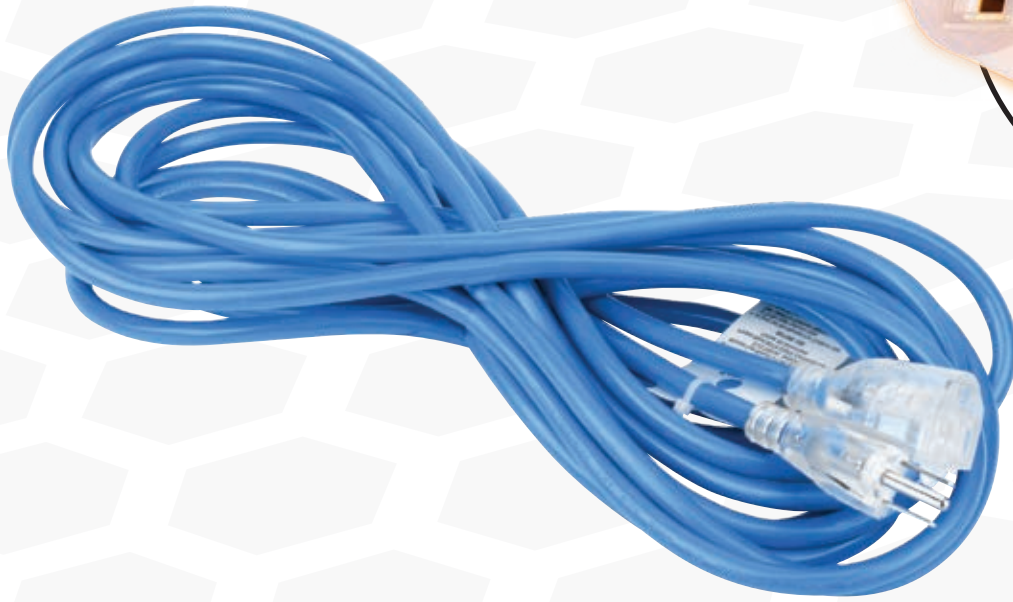

Lighted End.

Model	Description	Inner/Master	PKG	Display	UPC
W2256	BLUE 25FT 16GA EXTENSION CORD	1/18	SLV	No	039564122804

1400+ LUMEN DIRECT PLUG LED DROP LIGHT

All the durability of a traditional drop light with the efficiency of LED technology. Produces over 1000 lumens of bright white light. Impact resistant handle with non-slip rubber grip and base hook. Powder coated metal lamp shield with swivel hang hook. Built-in 120V outlet (600W MAX).

120V^{olt}

W2244



Direct Plug, extension cord not included.



**1400+
LUMENS**

Model	Description	Inner/Master	PKG	Display	UPC
W2244	1000+LM DIRECT PLUG LED DROP LIGHT	4/16	LAB	No	039564014673

