

Wilmar, LLC

PT POWER

**Northwest
Trail**

ATAK®

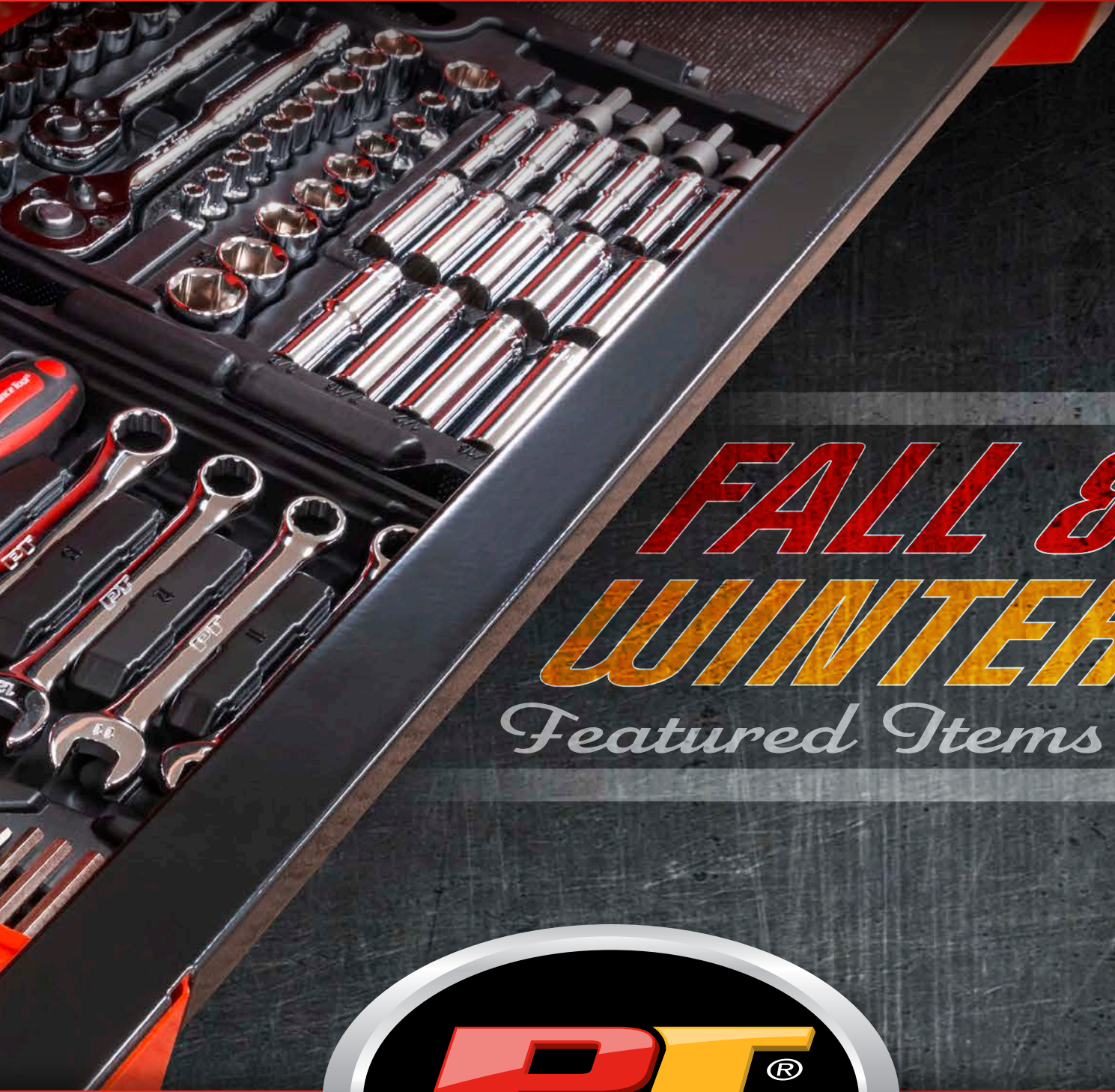

**FALL &
WINTER**
Featured Items



QUALITY | INNOVATION | SATISFACTION

HOLIDAY/GIFT

2.4 IN. LCD INSPECTION CAMERA

- 2.4 in. color LCD monitor with 320 x 240 VGA resolution
- Extra-long submersible 5/16 in. (8mm) diameter camera features 79 in. (200cm) flexible neck and 640 x 480 resolution
- In-Plane Switching (IPS) technology delivers better image representation and more accurate color at any angle
- 6 white LEDs with 3 brightness output levels
- Includes mirror, hook clip, magnet, charging cable, and built-in 18650 lithium ion battery



W50146 *
Inner: 1 Master: 30



250W PERSONAL SPACE HEATER

- 250-Watt makes this energy saving mini heater ideal for small spaces where a little extra heat is needed
- Efficient ceramic coils heat up in seconds while the quiet direct drive fan delivers 853 BTUs of warmth
- Safety is built in with tip-over and overheating protection



W5011 *
Inner: 1 Master: 6

LI-ION CORDLESS HEAT GUN

- The most compact rechargeable cordless heat gun on the market is only 4.8 ounces and lightweight enough to carry in your tool belt or repair kit
- Heats up to a maximum temperature of 600 degrees Fahrenheit (315C) within 10 seconds with a very focused, no flame output to protect surrounding components and wiring
- The built in 3.6V, 2.0Ah Lithium-Ion battery has a working time of 15-20 minutes and will maintain full charge for up to 6 months when stored
- Recharge battery in under 2 hours using the included USB compatible power cord and any USB power source with a 2.1A output or higher



W2082 *
Inner: 6 Master: 24

LEAD FREE SOLDER

- 0.031 inch Rosin Core Solder for any application
- Lead free solder - 99.3% tin, 0.7% copper
- 10 foot (3.0m) roll in storage tube



1500W CERAMIC SPACE HEATER

- With 3 settings, high-1500w, low-750w, and fan only, the heater puts out up to 5120 BTUs
- The heavy duty stainless steel heating coils with ceramic baffles delivers immediate and consistent heat
- The stay-cool housing is safe to touch even after hours of use at the highest heat setting
- The 120 volt, 12.5 amp heating element has built-in safeguards

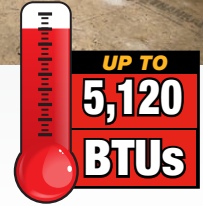

1500 WATT INFRARED SHOP HEATER

- Infrared technology heats up the person or object rather than the air
- Energy efficient operation converts nearly all energy into heat
- Carbon fiber glass enclosed tube heats up quickly and evenly
- Moisture resistant for operation in or covered outdoors (do not expose directly to rain or water)
- Adjustable thermostat levels for optimum indoor and outdoor comfort and automatic overheating shut-off
- 8-ft grounded cord



W5008 *
Inner: 1 Master: 1

700W VARIABLE SPEED BLOWER

- Amazing blowing power in a compact, easy to handle size
- Variable speed feature allows you to select just the right amount of power
- Two piece nozzle can be used at 9 inches or 18 inches
- Specs: 120 V AC, 60Hz, 700W, 5.8 AMPs, 17,000 max RPM, 90 MPH (145KPH) air speed, 100 CFM, 3.3 lbs (1.5kg), 98 db(A)

W50069 *
Inner: 1 Master: 4



10-WATT USB SOLDERING IRON

- High Output - reaches nearly 1000 degrees in about two minutes
- Easy to Use - simply plug into standard USB 2.0 or higher port and red indicator will come on confirming operation
- Versatile - operates from your computer, car, power bank, or any wall, power strip, or adapter with a USB outlet
- 48-inch (120cm) power cord gives you plenty of distance to safely work with
- Specifications: reached maximum temperature 932° F (500° C), in 130 seconds.



SCAN FOR VIDEO



44-PC BUTTON CELL BATTERY PACK

- Wide range of popular button cell replacement batteries
- Includes: 12pcs of AG13 (LR44), 6pcs of AG3 (LR41), 12pcs of CR2032, 6pcs of CR2016, 4pcs of CR2025 and 4pcs of CR1616

W483*
Inner: 8 Master: 48

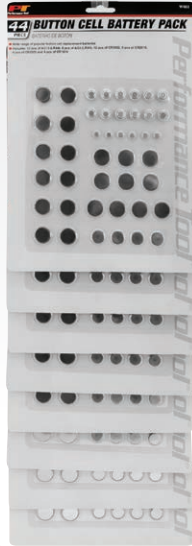
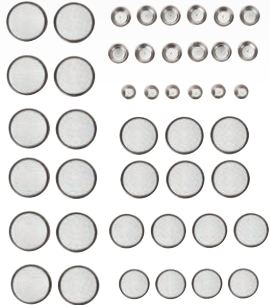

3.6V LI-ION LIGHT-DRIVER

- This 3.6v Li-ion Cordless Screwdriver with 2 position swivel handle for a pistol grip or straight in-line for tight spaces
- 1/4" hex rapid change chuck features an adjustable 15+1 clutch to deliver the right amount of torque
- Specifications: Battery: 3.6v 1300mAh Lithium-Ion, RPM: 210, Chuck: 1/4" Hex, Max. Torque: 5ft. lbs, Charger: 110v 1.0A, Charging speed: 2 hour

W1562*
Inner: 1 Master: 8



INCLUDES 50 MOST POPULAR BITS



104 SLOT BATTERY ORGANIZER

- Keep all your batteries organized and neatly stored while preventing corrosion and depletion from improper storage
- Features removable battery tester that doesn't require a battery



W3001*
Inner: 1 Master: 12

Holds up to 104 different size batteries: (45) AA, (36) AAA, (4) 9 volt, (8) C, (6) D and (5) CR2016, CR2025, or CR2032 button cells (Batteries not included)

PORTABLE SAFE/LOCKBOX

- Securely store your small valuables at home or on the go in this compact portable safe
- Can be secured with the included mounting bracket and hardware or 3 foot security cable - When box is locked it cannot be removed from the mounting bracket
- Includes bracket, mounting hardware, security cable and key

INTERIOR DIMENSIONS

7 X 5-1/4 X 2"

(17.7 X 13.3 X 5 cm)



W53998*
Inner: 2 Master: 10

CORDLESS SCREWDRIVER

- 1/4" Quick release chuck
- Automatic spindle lock
- Blue LED area light
- 180 RPM and reversible
- Includes storage/carrying case, 3 to 5-hour charger and 24 power tool accessories



W50033*
Inner: 1 Master: 10

USB VOLTAGE METER

- Allows you to monitor the charge voltage and current of your digital USB device to ensure the optimal charge rate
- Use to check the output voltage and amperage of mobile charger cables, power usage of your device, and compare the performance of USB chargers
- Specifications: DC voltage: 4-20V, +/- 1%; DC current: 0-5A, +/- 1%

W3002*
Inner: 12 Master: 192



While Supplies Last

MAGNETIC CUP HOLDER

- The built-in ceramic magnetics will stick to any ferrous metal surface
- Integrated ceramic magnets are covered by a scratch preventing rubber coating but are still powerful enough to hold up to 8 pounds
- The over-large 3-5/8" inside diameter holder
- Cup holder measures 3-5/8" diameter, 3-5/8" high in the front and 4-5/8" tall in the back

W12525*
Inner: 1 Master: 50



*California Residents Prop 65 warnings see page 36.



12V PORTABLE VACUUM CLEANER

- High powered suction in a compact, portable and lightweight unit
- Replaceable and washable HEPA filter captures smaller particles
- Operates directly from a 12V outlet in your vehicle
- On/off switch and power indicator
- Includes 5 attachments: crevice tool, bristled brush, dust brush, 11 in. hose, 10 in. extension
- Specifications: Input: 12V DC, 5A-7A, 80-100 Watts, 10A fuse; Cord Length: 4m (13.33 ft); Vacuum Pressure: 3000 Pa; Decibels: <80 dB

W50012 *
Inner: 4 Master: 16



INCLUDES 5 ATTACHMENTS

STEERING WHEEL CADDY DESK TOP

- This ergonomic desk caddy hooks to your steering wheel to provide an instant tray, or desk top
- Its double sided. Use one as a desk top for taking notes, or conducting business on your laptop
- Use the other side as a lunch table with a drink cut out and plenty of space to spread out your feast



W1283 *
Inner: 1 Master: 10

SOLD IN MASTER QUANTITIES
DOUBLE SIDED

12V 1/2 IN. DR. IMPACT WRENCH



- 1/2" drive impact wrench plugs into your vehicle's 12 volt DC outlet (cigarette lighter port) and delivers up to 250 ft. pounds of torque to remove lug nuts
- 12 ft. power cord easily reaches all four wheels and has an in line fuse to protect your tool and vehicle
- Comes with 4 impact grade, Chrome Vanadium, sockets to fit most common lug nut sizes - 11/16 in / 17 mm, 3/4 in / 19 mm, 13/16 in / 21 mm., 7/8 in. (23 mm.)
- Includes: 12v Impact wrench, plastic carrying case, 2 double sided impact sockets and a spare fuse

INCLUDES BLOW MOLD CASE

W50099 *
Inner: 1 Master: 6



12V HEATER/DEFROSTER

- Use this compact 12 volt heater to quickly defrost / warm windshields and surfaces
- 360 degree swivel base for dash mounting
- Swing-out handle lets you use the heater as a spot defroster
- 15 amp in-line blade fuse



W50099 *
Inner: 1 Master: 6

6 IN. USB MINI FAN

- Compact 4 inch aluminum blade and 6 inch frame delivers a lot of cooling air flow without taking up a lot of space
- 0.6mA brushless axial motor allowing for whisper quiet operation
- Sturdy metal stand with rubber feet is adjustable with 360 degrees of rotation
- Powered by a 3 foot USB cable

W1663 *
Inner: 6 Master: 24



12V HEATED TRAVEL BLANKET

- 3 heat settings, Low / Medium / High; up to 149°F (65°C) max
- Built-in automatic 45 minute timer prevents overheating and will not unintentionally drain your battery
- At approximately 43" x 59" and made out of plush polar fleece
- The extra long 94" power cord plugs into any DC accessory / cigarette lighter power outlet
- Specifications: Input: 12v DC, Max current: 4.5A, Rated power: 50-Watt, In line fuse: 8 Amp, Power cord: 94", Safety: Built in overload shut off

W6049 *
Inner: 1 Master: 6

12v out



USB WARMING LAP BLANKET

- Made of high quality polyester
- The heated area size is 20" x 12" and supplies gentle heat
- Specifications: Max heat: 100 degrees Fahrenheit (38C), Input: Standard USB plug, Max current: 5volt / 2amp, Power cord: 76", Material: black polyester, Safety: Built in overload shut off

W6046 *
Inner: 1 Master: 24

USB POWERED

1080-PC FASTENER ASSORTMENT

- 34 different fastener sizes, with matching hex nuts, washers and screws
- Unique stackable storage bins connect to each other for maximum portability
- Lid channels lock the dividers in place and help keep hardware from mixing
- The right mix for that special garage project, or use around the house
- Grade 2 Phillips head bolts, hex nuts and washers



W5263 *
Inner: 1 Master: 4

2-PC STACKABLE STORAGE CASE

- Unique stackable storage bins connect to each other for maximum portability
- Lids channels lock dividers in place keeping fasteners neatly organized without the ability to mixed
- Semi-transparent lid, comfortable carry handle, secure latches, and the ability to stack multiple cases
- Each of the two case has 18 separate bins for storage with removable dividers

W5266 *
Inner: 3 Master: 12

NEW

STACK PACKS



REMOVABLE CHANNELS



NEW



REMOVABLE CHANNELS

3-PC CAR SEAT CONVENIENCE SET

- Features tablet holder, utility clip and headrest bracket
- Adjustable bracket fits headrests with openings from 4-1/4" to 5-1/2" wide
- Quick connect system with easy push button release
- Fits tablets from 5-1/2" up to 9-3/4" wide/high
- Adjustable depth clips allow you to keep your protective case on your tablet
- Foam padding reduce shock and vibration to your device

W1284 *
Inner: 1 Master: 24



While Supplies Last



63-PC TITANIUM DRILL BIT SET

- Drill bits are made from #4241 high speed steel (HSS) and coated with Titanium-nitride to reduce heat, keeping the 118-degree split cutting edge sharper, longer
- Included is a hang-able, clear top indexed storage box to help you find the right bit quickly

W9012 *
Inner: 6 Master: 24



118° CUTTING HEAD



NEW

21 different bit sizes from 1/16 to 3/8 in. included: 1/16, 5/64, 3/32, 7/64, 1/8, 9/64, 5/32, 11/64, 3/16, 13/64, 7/32, 15/64, 1/4, 17/64, 9/32, 19/64, 5/16, 21/64, 11/32, 23/64, 3/8 in. Additional bits: (18) 1/16, (14) 1/8, (6) 3/16, (3) 1/4 in.

LI-ION LED CLIP FLEX LIGHT

- Low profile light bar provides 200+ lumens of warm white light
- Flexible neck allows you to position light wherever you need it
- Spring loaded clip features non-marring rubber padding and attaches to any object up to 1 inch (25mm) thick
- Specifications: 3 hour runtime, 3 hour charging time, 523450 1000mAh capacity lithium battery pack. Charging indicator is red while charging, green when full

W9209 *
Inner: 10 Master: 40



200+ LUMENS



Sold in INNER QUANTITIES

BOOT & SHOE BRUSH

- Wood blocks with heavy duty steel frame
- Easily screwed down to any surface using the integrated tabs
- Heavy poly bristles for long life

W9451 *
Inner: 1 Master: 6



ESSENTIAL FOR ANY RV

660LB DIGITAL SCALE

- Large digital LCD screen clearly shows weight in pounds, kilograms or stones
- Strong steel S-hook and O-ring to connect to hoist or gambrel
- Provides accurate readings up to 660 lbs (300kg)

W1478 *
Inner: 6 Master: 24



STADIUM BINOCULARS 7X50

- High Quality glass lenses produce crisp, clear images
- Ergonomic Rubberized Body for improved grip
- Fold down rubber eye cups for use with glasses
- Field of view 402ft at 1100 yards

W9460 *
Inner: 10 Master: 20



P TUBEZ

PLASTIC STORAGE CONTAINER

The reusable clear storage container is convenient, maximizes space, and makes it easy to see the tools. Available in two tube sizes: 9-1/4" x 3-1/2" small & 12-3/8" x 4-5/8" large, allows them to be merchandised virtually anywhere!



12-PC TRIM REMOVAL KIT

- Great kit for removing car stereo trim, door/dashboard panels, moldings, trim clips, or any other plastic interior or exterior components
- 12 multi-function trim tools provide 22 different end designs for removing interior and exterior trim, panels, and fasteners
- Made of durable nylon reinforced polypropylene that resists bending and breaking

NEW

W1760 * Small
Inner: 6 Master: 36



20-PC SCREWDRIVER KIT

- Alloy steel blades with satin finish and magnetic tips
- Non-slip molded grips provide better comfort and control
- 10 full size screwdrivers: 1/4" x 5", 3/16" x 5", 1/8" x 4", 3/32" x 3", 1/4" x 1-1/2" slotted; #2 x 4", #1 x 5", #0 x 4", #0 x 3", #2 x 1-1/2" Phillips
- 10 precision screwdrivers: 3/32" x 1-1/2" and 1/8" x 1-1/2" slotted; #0 x 1-1/2" and #00 x 1-1/2" Phillips; T5, T6, T7, T8, T9 and T10 x 1-1/2" Star

NEW

W1761 * Small
Inner: 6 Master: 36



54-PC ELECTRICAL KIT

- Wire stripper crimper strips and crimps 10-22 AWG, and cuts 4-40 to 10/32 soft steel fasteners
- Voltage tester determines if voltage is present and features insulated probe for 6V and 12V systems, and test lead with alligator clip
- Continuity tester determines a closed or open circuit, and test lead with alligator clip and 1AA battery operation (not included)
- Contents: Wire stripper/crimper; voltage tester, 3/4" x 30" electrical tape, 30 assorted electric connectors, 20 4" cable ties, continuity tester

W1762 * Small
Inner: 6 Master: 36



11-PC SAFETY KIT

- Safety glasses feature adjustable length arms and meet ANSI Z87.7-2003
- Knit gloves are lightweight, breathable, flexible, and feature dotted grip for a better grip
- (5) Dust masks for non-volatile solid and/or liquid irritants such as dust, dirt, mists and droplets
- Earplugs designed to reduce noise by up to 29db
- 2-7/8" x 30" Duct tape for anything and everything

NEW

W1763 * Small
Inner: 6 Master: 36



37-PC AUTO TOOL KIT

- Features SAE and metric sizes for a wide range of applications
- 1/4" Dr. ratchet and sockets: 3/16, 1/4, 9/32, 5/16, 11/32, 3/8, 7/16, 15/32 & 1/2 in.; 5, 6, 7, 8, 9, 10, 11, 12 & 13 mm
- 1/4" Bit Driver with bits: Phillips #0, #1, #2; Slotted 3/16, 1/4"; Star: T10, T15, T20 & T25; 1/4 in. adapter
- Also includes: brass detail brush, 0-50 PSI pencil tire gauge, 7 oz. funnel, compact flashlight (1AA battery not included), electrical tape, 6" slip joint pliers, and shop towel

W1770 * Large
Inner: 4 Master: 16



10-PC HOOK/PICK KIT

- Chrome vanadium steel shafts with comfortable non-slip molded grips
- LED magnetic pickup tool: features bright LED light, 8lb capacity magnet and cushion grip handle
- Telescoping pickup tool extends 27-1/2" to retrieve objects from confined areas. Requires (3) AG13 button cell batteries (included)
- Contents: (5) 10" (25.4cm) tools with 4" grips: straight pick, curved hook, 45° hook, 90° pick, and 1" scraper; (4) 6.5" (16.5cm) picks with 3.5" grips: straight; curved, 45°, and 90°

W1771 * Large
Inner: 4 Master: 16



9-PC WOODWORKING KIT

- Wallboard job saw for quick length or plunge cuts in wood, drywall and soft plastic
- T-bevel for angle matching, also features ruler markings
- A total of 6 clamps (four 1" spring clamps and two 4" ratcheting bar clamps) for holding, gluing or nailing
- Contents: (2) 4" mini bar clamps, (4) plastic spring clamps with 1" opening, wallboard saw with 6" blade, T-bevel, cleaning brush

W1772 * Large
Inner: 4 Master: 16



31-PC HOMEOWNER KIT

- Boz fiberglass claw hammer with drop forged head and comfortable rubber grip
- 9" triple vial torpedo level with magnetic base
- Retractable aluminum utility knife with blade
- 12" x 1/2" locking tape measure
- 1/4" hex magnetic bit and socket driving system features 20 1" power bits, and 6 1/4" drive sockets
- Bit sizes: 3/16", 1/4", 9/32" slotted; #0, #1, #2, #3 Phillips; 1/4" Drive adapter; T10, T15, T20, T25 Star; Metric Hex 3, 4, 5 & 6 mm, SAE Hex: 3/32, 1/8, 5/32 & 3/16"
- 1/4" Dr. socket sizes: SAE: 5/16, 3/8, 7/16, Metric: 10, 12, 13mm

W1773 * Large
Inner: 4 Master: 16



CLEAR TAPE MEASURE SETS

- Clear polycarbonate housing is lightweight and impact resistant with high-vis accent case colors
- Highly accurate SAE and Metric measurements
- Auto-retracting blade glides smoothly both in and out

W5039* - 4-PC

Inner: 4 Master: 16

4 pack of different length tapes: 12 ft. x 1/2 in. (purple), 16 ft. x 3/4 in. (green), 25 ft. x 1 in. (yellow), and 33 ft. x 1 in. (orange)

NEW



W5038* - 2-PC

Inner: 6 Master: 24

2 pack of different length tapes: 16 ft. x 3/4 in. (green) and 25 ft. x 1 in. (yellow)

NEW



6 FT. X 1/2 IN. CLEAR TAPE MEASURE

- High-grade polycarbonate housing is lightweight, always crystal clear, and impact resistant
- 1/2 in. blade with 2-sided, high contrast printing and stamped steel end hook
- High accuracy SAE and Metric measurements
- Auto-retracting blade glides smoothly both in and out



W5046*
Inner: 6 Master: 72

NEW

CLEAR TAPE MEASURES

- High-grade polycarbonate housing is lightweight, always crystal clear, and impact resistant
- 1 in. blade with 2-sided, horizontal and vertical, high contrast printing and double-sided end hook
- High accuracy SAE and Metric measurements
- Spring-assisted blade stop cushions hook as it retracts into case, preventing damage to the anchor rivets
- Auto-retracting blade glides smoothly both in and out

12 FT. x 1 IN.

W5044*

Inner: 8 Master: 48

16 FT. x 1 IN.

W5045*

Inner: 8 Master: 48

2-PC 25 FT. x 1 IN.

W5043*

Inner: 6 Master: 24

25 FT. x 1 IN.

W5042*

Inner: 8 Master: 48

33 FT. x 1 IN.

W5047*

Inner: 6 Master: 36

NEW



HEAVY-DUTY TAPE MEASURES

- Rubber coated, high-impact ABS case provides a secure grip for one-handed use
- Auto-lock mechanism holds the tape measure blade firmly in place as it is extended for easy handling
- High-performance heat-treated spring provides consistently smooth blade retraction
- 8 feet of stand-out and salt tested at 5X longer wear resistance than a non-coated tape
- High accuracy, MID class-2 certified measurements printed in black/red on both sides of the yellow blade: SAE standard on top and SAE/ fractional/ metric on the bottom
- Dual-sided triple riveted end hook slides to provide accurate inside/outside measurements

16 FT. x 1 IN.

W5053*

Inner: 12 Master: 36

25 FT. x 1 IN.

W5054*

Inner: 12 Master: 24

33 FT. x 1 IN.

W5055*

Inner: 12 Master: 24

NEW



6 IN. STAINLESS STEEL RULER

- Ultra-fine graduations in 10ths, 16ths, 20ths, 32nds, 50ths, 64ths of an inch on one side, and metric markings on the other
- Polished stainless steel finish that offers a durable life
- 6 in. total length (150mm) x 3/4 in. wide



W5708*
Inner: 6 Master: 48

NEW

6 IN. SLIDING DEPTH GAUGE

- Features ultra-fine black graduations in 64ths and 32nds of an inch for precise measurements
- Polished corrosion resistant steel offers a smooth, durable finish
- Decimal equivalent chart on the backside for 8ths, 16ths, 32nds, and 64ths of an inch
- Includes movable pocket clip for marking depth or step measurements and easy access



W5707*
Inner: 6 Master: 48

NEW

ANGLE MAKER TEMPLATE TOOL

- Four-sided ruler mechanism slides and locks at any desired angle to act as a reusable template
- Set 90-degree angles for parallel and perpendicular work pieces, use as a T-square to align your material, or consistently set precise distances
- Works on just about any material
- Special tightening/loosening mechanism for one-handed operation
- Two 6 inch (150mm) rules, and two 10 inch (250mm) rules feature SAE and metric measurements

W5710*

Inner: 12 Master: 48



NEW



DIGITAL ANGLE FINDER

- Multi-function measuring tool displays digital angle readings from 0-999.9° and features SAE and metric straight edge markings up to 7 in., each direction
- Dual scale ruler provides two 7 in. rulers for measuring two lengths simultaneously, and one continuous 400mm edge
- Digital angle finder measures inside/outside angles and operates as T-bevel protractor

W5709*

Inner: 10 Master: 60

Specifications: Measuring range: 0°-999.9° (reset to 0 before each use); Accuracy: 0.1°; Tolerance: ±0.3° (per angle measurement); Folded length: 220mm/8.5 inch; Expanded length: 400mm/15.75 inch



NEW

SAE & METRIC MARKINGS

ADJUSTABLE SCRIBER COMPASS

- Two in one tool is a scriber for marking soft surfaces, and accommodates a standard size pencil for use as a compass
- Great for drawing or marking out circle cuts and contours up to 8 in. (20cm) in diameter
- Use with a scribe or hobby knife to score or cut circles

NEW



W7555 *
Inner: 20 Master: 240

6 IN. PRECISION PENCIL COMPASS

- High quality professional grade compass/divider for design work, math, geometry, art, drafting drawing and more
- Precision designed with spring bow fulcrum, and fine threaded rod and center wheel to create near perfect circles up to 10 inches (250mm) in diameter
- Includes spare screws and 3 replacement pencil tips



W7556 *
Inner: 20 Master: 160

NEW

JUMBO INSPECTION MIRRORS

- Comfortable injection molded grip
- Double ball joint swivel for operation at any angle



360 DEGREE ARTICULATION

NEW

W1255 * - 2 IN.
Inner: 12 Master: 144
Extends from 10 in. (25cm)
to over 36 in. (90cm)

W1257 * - 3.5 IN.
Inner: 12 Master: 120
Extends from 12 (30cm) inches
to over 30 inches (75cm)

3-PC RETRIEVAL TOOL KIT

- Three must-have tools for every shop, garage or repair facility
- Includes: 24 inch claw retrieval tool, 21 inch extendable 2 inch mirror and 24 inch magnetic pick up tool
- Telescoping mirror and magnetic tool collapse down to about 6 inches for easy storage



W1936 *
Inner: 12 Master: 48

MAGNETIC



6 IN. VERNIER CALIPER

- Quality steel construction provides precise inside, outside, and depth measurements up to 6 inches (150mm)
- Knurled thumb lock and sliding wheel for accurate measuring and recording
- Dual scale provides standard measurements up to 1/16th of an inch, and metric scale to 1mm



W80163 *
Inner: 12 Master: 48

SAE & METRIC

NEW

5-PC HOOK & PICK SET

- Versatile tools ideal for pulling and picking up small hard to grasp objects
- Five styles give you a range of functions: curved hook, offset hook, 90 degree hook, straight pick, flat o-ring remover
- Includes clear vinyl pouch to keep everything organized together

NEW

Sold in INNER QUANTITIES

W9216 *
Inner: 12 Master: 72



4.5 IN. POCKET PICK-UP TOOL

- 4 claw design easily picks up very small items, difficult to retrieve from flat surfaces or tight spaces fingers can't reach
- Spring-loaded prongs firmly grip small items with almost no effort from the user
- Cast aluminum body with heavy cross-hatched knurling, provides a firm grasp even in wet hands



W83190 *
Inner: 12 Master: 144

POCKET SIZED

NEW

SWIVEL HEAD DEBURRING TOOL

- Ideal tool for removing burrs and imperfections from the surface of cut pipe, PVC, conduit and other tubing
- Aluminum handle with precision tempered M2 steel blades for metal, copper, aluminum, plastic, cast iron and brass applications
- Swivel head operates in a circular motion to quickly smoothen uneven surfaces
- Time-saving quick release blade change with spring loaded release collar



NEW

W2960 *
Inner: 6 Master: 48

FLEXIBLE MAGNETIC PICKUP TOOL

- Rigid flexible pickup tool bends to any position and stays there
- 1.5 lb. (0.68Kg) capacity magnetic head is only 5/16 in. (8mm) in diameter
- 24 in. (61cm) flexible aluminum neck with knurled aluminum handle



W83191 *
Inner: 12 Master: 72

NEW

LED INSPECTION MIRROR PICKUP TOOL

- Features 2 lighted tools in 1 - inspection mirror and pickup tool
- Extends to over 34 inches (86cm)
- Mirrors snaps on/off for access and retrieval in confined areas
- Requires (2) CR2032 button cell batteries (included)

W1263 *
Inner: 10 Master: 60



NEW

DIGITAL MOISTURE METER

- Dual function digital moisture meter measures wood, concrete, drywall, and other non-metallic materials to determine moisture content
- Color-changing backlit LCD display clearly and quickly indicates whether moisture is within a safe range
- Integrated thermometer reads ambient temperature in F° or C°
- Includes rubber safety cover, lanyard, and 2AAA batteries



NEW

TRI-COLOR DISPLAY

W89718 *
Inner: 12 Master: 48



SCRATCH AWL/HOLE STARTER

- Great for puncturing a variety of materials with minimal effort, as a scribe, pilot hole starter and more
- Use to go through surfaces of soft materials, like thin plastic, leather, rubber, fabrics, and more
- Chrome plated, corrosion resistant 3.75-inch (95mm) long alloy steel blade



NEW

COMFORT MOLDED GRIPS

W7553 *
Inner: 6 Master: 48



5 IN. UTILITY CENTER PUNCH

- Heavy duty spring-loaded operation delivers a powerful strike with one hand operation (no hammer required)
- Use as an automatic center punch to mark, scribe, punch, and start drill, nail or screw holes, even to break glass
- Precise dual coil spring action and hardened steel point with adjustable tension
- Durable, lightweight aluminum construction with knurled grip

W7551*
Inner: 6 Master: 48



6 IN. CARBIDE TIP SCRIBER

- Hardened tungsten carbide tip great for marking treated steel, stainless steel, glass, ceramic, stone, and more
- Corrosion resistant aluminum body is lightweight and durable and features knurling for a positive grip
- Integrated magnet for use as a retrieval tool in hard to reach spots
- Convenient pocket clip for easy carry and access

W7552*
Inner: 16 Master: 192



W1737* - 44-PC w/RACK
Inner: 1 Master: 4

Sizes: 1/8 x 3", 5/32 x 4", 3/16 x 4", 1/4 x 5", 5/16 x 6" Slotted; #0 x 3", #1 x 3", #2 x 4", #3 x 6" Phillips; T20 x 4", T25 x 4", T27 x 4", T30 x 5", T40 x 4" Star; S1 x 3", S2 x 3", S3 x 4" Square. On-board SAE and metric hex key sets: 1/16, 5/64, 3/32, 1/8, 5/32, 3/16, 7/32, 1/4"; 1.5, 2, 2.5, 3, 4, 5, 5.5, 6mm. Integrated bit holder with 10 tamper resistant star bits sizes: T8, T9, T10, T15, T20, T25, T27, T30, T35 & T40.



GO-THRU SCREWDRIVER SETS

- Color coded, ergonomic non-slip molded grips for improved comfort and control
- High strength go-through shank design features smooth striking face end caps
- Heat-treated satin plated hexagonal shafts with black magnetic tips

NEW



W1740* - 6-PC
Inner: 1 Master: 6
Sizes: 3/16 x 6", 1/4 x 6", 5/16 x 6"
Slotted; #1 x 6", #2 x 6", #3 x 6" Phillips

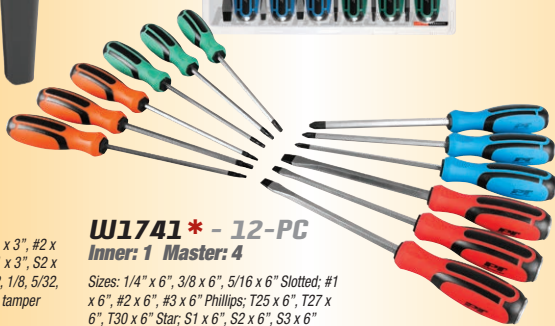

W1741* - 12-PC
Inner: 1 Master: 4

Sizes: 1/4" x 6", 3/8 x 6", 5/16 x 6" Slotted; #1 x 6", #2 x 6", #3 x 6" Phillips; T25 x 6", T27 x 6", T30 x 6" Star; S1 x 6", S2 x 6", S3 x 6"

61-PC SCREWDRIVER & BIT SET

- FREE STANDING STORAGE/ORGANIZING RACK - features bit storage and removable magnetizer/demagnetizer
- Heat treated alloy steel blades with satin finish, magnetic tips and non-slip molded grips
- Most popular Phillips, slotted, star and square sizes
- Storage/organizing rack

W1731*
Inner: 1 Master: 4

INCLUDES STORAGE RACK



39-PC SCREWDRIVER SET W/ RACK

- Organizing rack features built-in bit holders and magnetizer/demagnetizer
- Chrome vanadium blades and power bits
- Comfortable non-slip molded grips
- Satin finish with magnetic tips
- Magnetic Bit Driver
- Storage/Organizing Rack

W1727*
Inner: 1 Master: 6

INCLUDES STORAGE RACK



INCLUDES STORAGE RACK

30-PC SCREWDRIVER SET WITH RACK

- Comfortable non slip molded grips
- Chrome vanadium blades and power bits with magnetic tips
- Satin finish
- Compact storage rack keeps all tools organized
- Contents: slotted and Phillips screwdrivers, regular and precision

W1718*
Inner: 4 Master: 8



34-PC SOCKET AND BIT DRIVER SET

- Ratcheting 1/4" hex bit driver has 3 settings; loosen, tighten and fixed
- Ergonomic comfort-grip handle reduces hand fatigue and provides a non-slip operation
- Magnetic shaft will help hold your fasteners or nuts securely during use

W9082*
Inner: 6 Master: 36

RATCHETING DRIVER



DRIVERS

5-PC LOW PROFILE SAE HEX KEY SETS

- Low profile design feature 3/8 inch (10mm) clearance, and a 15° offset angle for improved access for hard to reach fasteners
- Corrosion resistant heat treated steel handles with durable S2 alloy steel bits
- Includes key ring & carabiner clip for convenient organization and compact storage

W86108* - SAE
Inner: 12 Master: 96
 Includes 5 popular sizes: 1/8, 5/32, 3/16, 7/32, 1/4 inch

SAE

W86109* - METRIC
Inner: 12 Master: 96
 Includes 5 popular sizes: 2.5, 3, 4, 5, and 6mm

METRIC



LOW PROFILE DESIGN

15° OFFSET

5-PC LOW PROFILE SCREWDRIVER SETS

- Low profile design feature 3/8 inch (10mm) clearance, and a 15° offset angle for improved access for hard to reach fasteners
- Corrosion resistant heat treated steel handles with durable S2 alloy steel bits
- Includes key ring & carabiner clip for convenient organization and compact storage

W30977* - SCREWDRIVERS
Inner: 12 Master: 96
 Includes 5 popular sizes: Phillips #1, #2, Pozzi P21, P22, and slotted 3/16 inch (6mm)

W30978* - STAR
Inner: 12 Master: 96
 Includes 5 popular star sizes: T20, T25, T27, T30, T40



STAR

18-PC TAMPER RESISTANT STAR BIT SET

- Interchangeable bit socket system features sixteen tamper resistant star bits sizes
- Chrome vanadium alloy steel construction for strength and durability
- Polished nickel chrome plated bit holders resist corrosion, and are heat-treated for added durability

W1383*
Inner: 8 Master: 48
 Contents: 3/8 drive x 1/4 inch, & 3/8 drive by 5/16 inch hex adapters; 1/4 inch Hex bit sizes: T6, T7, T8, T10 (2), T15 (2), T20 (2), T25, T27, T30; 5/16 inch Hex bit sizes: T40, T45, T50, T55



NEW

7-PC MICRO 1/4 IN. BIT RATCHET SET

- Low-profile, compact design is great for tight work spaces
- Alloy steel construction for strength and durability
- Polished nickel plated finish resists corrosion
- 36 gear teeth for precise 10 degree sweep
- 1/4" hex with 1/4" drive socket adapter, and 5pc color coded CrV bits with holder: Phillips #0, #1, #2, Slotted 3/16, 1/4"



LOW PROFILE DESIGN

Sold in INNER QUANTITIES

NEW

36



W490*
Inner: 12 Master: 144

8-PC FOLDING HEX KEY SETS

- Chrome vanadium steel construction
- Fold out drivers for compact convenient use
- Color coded

W80282* - SAE
Inner: 6 Master: 24
 SAE sizes: 1/16, 5/64, 3/32, 1/8, 5/32, 3/16, 1/4 and 5/16"



SAE

W80283* - METRIC
Inner: 6 Master: 24
 Metric sizes: 1.5, 2, 2.5, 3, 4, 5, 6 and 8mm



METRIC

W80284* - STAR
Inner: 6 Master: 24
 Star sizes: T9, T10, T15, T20, T25, T27, T30 and T40



STAR

2-IN-1 RATCHETING SCREWDRIVER

- Extendable double sided bit includes 2# Phillips and 1/4 inch slotted tips
- 6 Inch (150mm) multi-position bit allows for up to 12 different length settings
- Handle features 1/4 inch hex chuck for use as a t-handle when more torque is needed
- 18 gear teeth ratcheting mechanism delivers maximum torque

Sold in INNER QUANTITIES

W9214*
Inner: 6 Master: 48



18 GEAR TEETH



3-PC FOLDING HEX/STAR KEY SET

- SAE, Metric and Star included in set
- Fold out drivers are compact and convenient
- Color coded for easy identification

COLOR CODED HANDLES

W80287*
Inner: 6 Master: 24
 SAE sizes: 1/16, 5/64, 3/32, 1/8, 5/32, 3/16, 1/4 and 5/16". Metric sizes: 1.5, 2, 2.5, 3, 4, 5, 6 and 8mm. Star sizes: T9, T10, T15, T20, T25, T27, T30 and T40

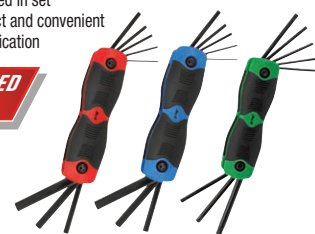

Limited to stock on hand.

52-PC FOLDING UTILITY KNIFE SET

- Combines the strength of a fixed blade w/convenience of pocket knife
- Compact design folds down to 3 9/16" for easy storage & portability
- Handy belt clip
- Includes 50 standard utility knife blades

W1720*

Inner: 6 Master: 24

INCLUDES 50 REPLACEMENT BLADES



BX5 DUAL SAFETY UTILITY KNIFE

- 2-in-1 Safety Utility Knife - combines the safety of a self-retracting knife, with the strength of a retractable utility knife
- In standard mode, press down on the rearward button and slide forward to one of two exposed blade lengths
- Includes flip-top blade holder and 10 BX5 utility blades, made of high quality SK2 steel that lasts up to 5X longer than standard steel blades



AUTO RETRACT

W689*

Inner: 12 Master: 72

NEW

3-IN-1 MULTI-CUTTER

- Three tools in one - anvil cutter, wire cutter and box cutters
- Heat treated and hardened carbon steel blades
- Titanium coated wire cutter makes it easy to trim 7mm diameter copper, aluminum and soft steel wire or cable and up to 4mm diameter nails
- Retractable anvil exposes 3/8 inch (10mm) of the blade for cutting boxes, carpet, drywall and more
- Includes 3 extra blades stored in handle

W2045*

Inner: 6 Master: 24



REPLACEMENT BLADES

W2045-1*

Inner: 12 Master: 144

Includes 2 cartridges with 3 blades each, designed to slide directly into Multi-Cutter handle



BOOST PLIERS

- Patented dual joint design delivers 60% more leverage providing a boost of power over regular pliers
- Induction hardened and precision sharpened cutting edges
- 30% larger grips offer additional comfort and deliver more cutting/gripping power
- Swivel thumb lock for safe and secure storage

W30791* - DIAGONAL

Inner: 6 Master: 48

While Supplies Last

W30792* - LONG NOSE

Inner: 6 Master: 48

While Supplies Last

W30793* - LINESMAN

Inner: 6 Master: 48

60% MORE LEVERAGE
BOOST

COMFORT MOLDED GRIPS



11 IN. RATCHETING GROOVE JOINT

- EFFICIENT - Ratcheting design allows you to quickly adjust jaw opening size
- VERSATILE - Multi-purpose jaw grips feature large and small teeth, and flat and angled surfaces
- EFFECTIVE - Precision machined ratcheting channel offers more jaw positions than standard tongue-and-groove pliers
- Adjustable jaw capacity up to 2-1/2 inch (64mm)



NEW



W30742*
Inner: 10 Master: 50

1/4 to 2-1/2"
(6.4-64 mm)

60% MORE LEVERAGE



ERGONOMIC GRIP



THUMB LOCK



REVOLVING HOLE PUNCH PLIERS

- High leverage, double hinged handle design delivers more power with less effort
- Hardened punch wheel features six common sizes for making clean cut holes in a variety of materials
- Brass plated, zinc alloy punch plate is oversized and extra thick for better performance
- Alloy steel handles with corrosion resistant finish and hang hole inside grips



W7554*

Inner: 12 Master: 48



8-PC PLIER & WRENCH SET

- Chrome Vanadium steel construction
- Machined jaws for maximum gripping strength
- Cutting pliers feature induction hardened cutting edges for durability
- Contents include 4 1/2" mini long nose plier, 4 1/2" mini diagonal pliers, 6" long nose pliers, 7" linesman pliers, 8" adjustable wrench, 8" slip joint pliers, and 10" groove joint pliers



W1704*

Inner: 6 Master: 12

5-PC PLIER SET

- Durable alloy steel construction
- Non slip molded grips for comfort and control
- Set contains 1 each 6" slip joint pliers, 7" diagonal pliers, 8" long nose pliers, 8" linesman pliers and 10" groove joint pliers



W1717*

Inner: 6 Master: 12

2-IN-1 DUAL JAW QUICK PLIERS

- Unique design switches easily from long nose, wire stripping/cutting pliers, flat/curved gripping pliers
- Durable chrome vanadium construction for improved cutting, gripping, turning, holding, and more
- Total length: 7-1/4" (18.4cm), 0.75" (19mm) jaw capacity, 10GA cutting capacity, strips 12GA and 16GA wire



NEW

COMFORT MOLDED GRIPS

REVERSIBLE

W1105*

Inner: 6 Master: 36

TOOL SETS

47-PC 1/4 IN. DR. SOCKET SET

NEW

- Drop forged carbon steel with corrosion resistant chrome plated finish
- Wide range of standard sockets and bit sockets in SAE and Metric sizes
- Ratchet, bit driver and sockets give you a comprehensive nut, bolt, and screw driving system

W1177*
Inner: 5 Master: 20



19-PC 3/8 IN. DR. SOCKET SET

- 18 SAE and Metric sockets in popular sizes
- Sturdy ratchet with full length handle for leverage
- Convenient rail/ratchet storage hanger

W38301*
Inner: 6 Master: 24



6pt SAE Sizes: 3/8, 7/16, 15/32, 1/2, 9/16, 5/8, 11/16, 3/4 and 13/16".
6pt MM sizes: 9, 10, 11, 12, 13, 14, 15, 17 and 19mm.

38-PC COMPACT AUTO TOOL KIT

- GREAT EMERGENCY KIT: Perfect to keep in your trunk in case of emergencies, this Ki can address a multitude of problems with cars
- COMPACT: With so many tools in one small kit, you'll have whatever you need wherever you go
- ZIPPERED CASE: Nylon case closes securely and is tough enough to take to any job
- Includes a bit driver and bits, sockets and accessories, adjustable wrench, pliers, compact flashlight, tire gauge, 12-volt tester and more in a convenient and compact nylon zippered case



W1197*
Inner: 6 Master: 24

265-PC TRI-FOLD SET WITH CABLE TIE



W1519*
Inner: 1 Master: 5

Contents: Fully polished 3/8" drive pro style ratchet, 3/8" and 1/4" drive SAE and metric sockets, 3/8" drive 3" extension, universal joint, 3/8" F to 1/4" M adapter, 3/8" drive spark plug sockets (5/8" and 13/16"), Long nose plier, diagonal cutter and 6" adjustable wrench, 10 SAE and metric combination wrenches, Magnetic bit driver with 20 pc bit set with holders, Stainless steel scissors, Wire crimper with 44 assorted terminals in storage box, Detail brush, break-away knife, electrical tape, 10 ft tape measure



123-PC MECHANIC'S TOOL SET

- Comprehensive selection of tools including sockets, wrenches, pliers, screwdrivers, hex keys and more
- Features SAE and metric sizes for a wide range of applications
- Blow molded storage/carrying case
- Extremely versatile set for repairs around your home, auto garage, workshop, RV or boat

W1801*
Inner: 1 Master: 3



119-PC TOOL SET

- Set features: Ratchet, SAE and metric sockets and accessories, pliers, wrenches, screwdrivers, bit drivers with bits and much more
- Heavy duty blow molded case



W1193*
Inner: 1 Master: 5

125-PC SOCKET & WRENCH TOOL SET

- Set features: ratchets, SAE and metric sockets with accessories, screwdrivers, wrenches, pliers, hex key sets, bit driver with bits and much more

W1525*
Inner: 1 Master: 4



155-PC MECHANIC'S TOOL SET

- Features high torque, quick release, 72 gear teeth ratchets that allow for a 5 degree sweep
- 6pt SAE and Metric standard and deep wall sockets in 1/4 and 3/8" drive sizes
- Chrome vanadium alloy steel for strength and durability



SAE
METRIC



W30502*
Inner: 1 Master: 4

134-PC MECHANIC'S TOOL SET

- Features high torque, quick release, 72 gear teeth ratchets that allow for a 5 degree sweep
- 6pt SAE and Metric standard and deep wall sockets in 1/4 and 3/8" drive sizes
- Chrome vanadium alloy steel for strength and durability



SAE
METRIC



W30501*
Inner: 1 Master: 4

Limited to stock on hand.

1/4 IN. DR. UNIVERSAL SPLINE SET

- Universal design works with SAE and Metric spline, partially rounded, 6pt, 12pt square and star sizes
- 47 total pieces equivalent to a 175pc socket set
- Chrome vanadium alloy steel for strength and durability
- Universal spline sockets in standard and deep wall

EQUIVALENT TO
175
PIECES

47 TOTAL PIECES



W36193*
Inner: 1 Master: 10

UNIVERSAL SPLINE DESIGN FITS ALL THESE SIZES

METRIC	SAE	6 POINT	12 POINT	STAR	SQUARE
4 mm	5/32 in.	X	X	E5	
4.5 mm	3/16 in.	X	X		
5 mm	13/64 in.	X	X		4
5.5 mm	7/32 in.	X	X		4.5
6 mm	1/4 in.	X	X	E8	5
7 mm	9/32 in.	X	X		
8 mm	5/16 in.	X	X	E10	
9 mm	11/32 in.	X	X		
10 mm	3/8 in.	X	X	E12	8
11 mm	7/16 in.	X	X	E14	9
12 mm	15/32 in.	X	X		10
13 mm	1/2 in.	X	X	E16	
14 mm	9/16 in.	X	X	E18	
15 mm	19/32 in.	X	X		12
16 mm	5/8 in.	X	X	E20	13
17 mm	11/16 in.	X	X		14
18 mm	23/32 in.	X	X	E22	
19 mm	3/4 in.	X	X	E24	



3/8 IN. DR. UNIVERSAL SPLINE SET

- Universal design works with SAE and Metric spline, partially rounded, 6pt, 12pt, square and star sizes
- 52 total pieces equivalent to a 189pc socket set
- Chrome vanadium alloy steel for strength and durability
- Universal spline sockets in standard and deep wall

EQUIVALENT TO
189
PIECES

52 TOTAL PIECES



W38193*
Inner: 1 Master: 4

52-PC 1/4, 3/8 & 1/2 IN. DR. SOCKET SET

- 3/8" and 1/2" dr. ratchets, extension bar, adapter, 1/4" spinner handle
- 1/4, 3/8 and 1/2" dr. sockets: 5/32 - 7/8" and 4 - 17mm

W1172*
Inner: 1 Master: 5



40-PC 1/4 & 3/8 IN. DR. SOCKET SET

- Ratchet, extension bar, 1/4" spinner handle, spark plug socket, adapter and more
- 1/4" and 3/8" dr. socket sizes: 5/32" to 3/4" and 4mm to 17mm
- Sturdy blow molded case

W1173*
Inner: 1 Master: 10



75-PC HOMEOWNERS TOOL SET

- Storage/Carrying Case



Contents: 8 oz Steel Hammer with Rubber Grip, 2 Screwdrivers: 1/4" x 4" slotted, #2 X 4" Phillips, 6 Screwdrivers: 1/16, 3/32, 1/8" slotted, #0, #00, #000 Phillips, 12 ft Fractional readout tape measure, Snap-blade Knife, Torpedo Level, and Assorted Fastener Kit.

W1543*
Inner: 1 Master: 10

85-PC SOCKET SET

- Drop forged chrome plated carbon steel
- Wide range of SAE and Metric sockets in 3 drive sizes
- Storage / Carrying Case

W1183*
Inner: 1 Master: 5



45-PC STUBBY SET

- 72 gear teeth dual drive ratchet: 1/4" and 3/8" drives in one ratchet
- Ratcheting screwdriver: clockwise, counter clockwise and locking positions
- Stubby adjustable wrench has 1" rule on head for precision adjustments
- Alloy steel construction for strength and durability

W39000*
Inner: 6 Master: 12



285-PC AUTOMOTIVE ELECTRICAL REPAIR KIT

- Great for use on automotive, marine, industrial and agricultural applications
- 2 part plastic case folds open 180° for easy access to both sides of kit

W5207*
Inner: 1 Master: 12



52-PC SOCKET & BIT DRIVER SET

- The 1/4" drive mechanics style ratchet comes with 1/4" square 3" extension and 1/4" hex adapter to drive all sockets and screw driver bits included
- The 2 - 3" magnetic bit holders to extend your reach and hold your fasteners and bits secure during use



W9046*
Inner: 4 Master: 24

38-PC IMPACT SOCKET SET

- Drop forged chrome vanadium steel for strength and durability
- Large size laser etching for easy identification
- Rounded corners for a tighter grip
- Includes SAE & Metric, deep and standard sizes

M796*
Inner: 1 Master: 5



Contents: 20 1/2" Dr skts: 7/16, 1/2, 9/16, 5/8, 11/16, 3/4, 13/16, 7/8, 15/16, 1", 11, 12, 13, 14, 16, 17, 18, 21, 22, 24mm. 16 3/8" Dr DW skts: 5/16, 3/8, 7/16, 1/2, 9/16, 5/8, 11/16, 3/4", 8, 10, 11, 12, 13, 14, 17, 18mm, adapter.



PROFESSIONAL HAND TOOLS

8FT PROFESSIONAL HAND TOOL PLANOGRAMS

- Full line of SAE and metric combination wrenches, sets, and various specialty wrenches and sets
- Complete range of 1/4, 3/8 and 1/2 inch ratchets, drive tools and accessories
- Comprehensive offering of 3/8 inch and 1/2 inch drive sockets, deep and shallow, and sets in all three drive sizes

NEW

TOOL ASSORTMENTS CATALOG



SCAN TO VIEW
(FILE SIZE 45MB)



SOCKETS & TOOL SETS

- Additional selection of ratcheting wrench, screwdriver, specialty socket bit socket sets, and mechanic's tool sets

W59408* - 6 POINT

Inner: 1 Master: 1

W59409* - 12 POINT

Inner: 1 Master: 1

SOCKETS & PLIERS

- Additional selection of gripping, cutting and locking pliers, and Phillips and slotted screwdrivers and sets

W59418* - 6 POINT

Inner: 1 Master: 1

W59419* - 12 POINT

Inner: 1 Master: 1



SAE

METRIC

1/2 IN. DR 12PT DEEP WALL SOCKETS

- 12 point recessed edges for a better fit on a wider variety of fasteners
- Socket openings are designed to reduce fastener rounding
- Chrome vanadium alloy steel construction for strength and durability
- Polished nickel chrome plated finish resists corrosion
- Large stamping for quick identification



SAE

W32632* - 1 IN.

Inner: 6 Master: 48

W32634* - 1-1/16 IN.

Inner: 6 Master: 48

W32640* - 1-1/4 IN.

Inner: 6 Master: 48

METRIC

W32710* - 10MM

Inner: 6 Master: 48

W32712* - 12MM

Inner: 6 Master: 48

W32713* - 13MM

Inner: 6 Master: 48

W32714* - 14MM

Inner: 6 Master: 48

W32715* - 15MM

Inner: 6 Master: 48

METRIC

W32716* - 16MM

Inner: 6 Master: 48

W32717* - 17MM

Inner: 6 Master: 48

W32718* - 18MM

Inner: 6 Master: 48

W32719* - 19MM

Inner: 6 Master: 48

W32721* - 21MM

Inner: 6 Master: 48

W32722* - 22MM

Inner: 6 Master: 48

W32723* - 23MM

Inner: 6 Master: 48

W32724* - 24MM

Inner: 6 Master: 48

W32727* - 27MM

Inner: 6 Master: 48



NEW

3/8 IN. DR 1/4 IN. 12PT SOCKET

- 12 point recessed edges for a better fit on a wider variety of fasteners
- Socket openings are designed to reduce fastener rounding
- Chrome vanadium alloy steel construction for strength and durability
- Polished nickel chrome plated finish resists corrosion
- Large stamping for quick identification

W38508*

Inner: 6 Master: 48

NEW



3/8 IN. DR. DEEP SOCKET 18MM

- Recessed edges
- Socket openings are designed to reduce fastener rounding
- Chrome vanadium alloy steel construction for strength and durability
- Polished nickel chrome plated finish resists corrosion
- Large stamping for quick identification

W38418*

Inner: 6 Master: 48



Limited to stock on hand.

7-IN-1 RATCHETING WRENCH SETS

- Versatility - Socket insert system provides 7 different sizes in one compact package
- Flexibility - Head pivots a full 180° for operation at any angle giving you access to confined areas
- Convenience - Reusable storage case keeps everything neat and organized, and can hang on a hook
- 72 Gear teeth for 5° sweep - flip wrench over to reverse direction



NEW

W30648* - SAE
Inner: 12 Master: 48

Sizes: 5/16", 3/8", 7/16", 1/2", 9/16", 5/8", 3/4"

W30649* - METRIC
Inner: 12 Master: 48

Sizes: 8mm, 10mm, 12mm, 13mm, 14mm, 17mm and 19mm

72 GEAR TEETH

FLEX HEAD



28-PC SAE & MET WRENCH SET

- Chrome vanadium steel construction
- Full length pattern, flat panel design
- Hinged storage/organizing rack features fold out panels for easy access
- Mirror polished chrome finish for easy cleanup
- Standard Sizes: 1/4, 5/16, 3/8, 7/16, 1/2, 9/16, 5/8, 11/16, 3/4 inch, 6, 8, 10, 12, 13, 14, 15, 17, 18mm
- Stubby Sizes: 3/8, 7/16, 1/2, 9/16, 5/8 inch, 10, 12, 13, 14, 15mm



W1093*

Inner: 1 Master: 6

White Supplies Last

22-PC COMBINATION WRENCH SET

- Chrome Vanadium Steel Construction
- Full pattern raised panel design
- Chrome plated finish
- Handy storage rack
- Sizes: SAE: 1/4, 5/16, 3/8, 7/16, 1/2, 9/16, 5/8, 11/16, 3/4, 13/16 and 7/8", Metric: 6, 7, 8, 9, 10, 11, 12, 13, 14, 17 and 19mm



W1084*

Inner: 1 Master: 6

32-PC SAE & MET WRENCH SET

- Mirror polished chrome vanadium steel
- SAE: 1/4, 5/16, 11/32, 3/8, 7/16, 1/2, 9/16, 5/8, 11/16 & 3/4"
- Stubby: 5/16, 3/8, 7/16, 1/2, 9/16 & 5/8"
- Metric: 6, 8, 10, 11, 12, 13, 14, 15, 17 & 18 mm
- Stubby: 10, 11, 12, 13, 14 & 15 mm

W1099*

Inner: 1 Master: 5

SAE

METRIC



7 SLOT STUBBY WRENCH RACK

- Rubberized polymer construction resists fuels and chemicals and has no sharp edges
- Non-slip slots lock in wrenches while still allowing easy one-handed removal
- Full-size handle folds down to save space in toolbox drawer
- Low profile fits shallow tool box drawers

SAE

METRIC

W30594* - METRIC

Inner: 5 Master: 50

Designed for metric sizes wrenches: 8, 9, 10, 11, 12, 13 and 14mm

W30593* - SAE

Inner: 5 Master: 50

Designed for SAE sizes wrenches: 5/16, 3/8, 7/16, 1/2, 9/16, 5/8, 11/16 inch

White Supplies Last



7-PC RATCHETING WRENCH SETS

- Chrome plated to resist corrosion and fully polished for easy cleanup
- Low profile head for access in tight spaces
- 72 gear teeth for a precise 5 degree sweep
- Drop forged chrome vanadium steel



W1088* - SAE

Inner: 6 Master: 24

Sizes: 5/16, 3/8, 7/16, 1/2, 9/16, 5/8, and 3/4 inch

W1089* - METRIC

Inner: 6 Master: 24

Sizes: 8, 10, 12, 13, 14, 15 and 18mm



8-PC OFFSET BOX WRENCH SETS

60° OFFSET

- Drop forged chrome vanadium steel construction
- Fully polished finish with 12-point box ends
- 60° offset for hard to reach fasteners
- Handy storage rack

W1085* - SAE

Inner: 6 Master: 12

Sizes: 1/4 x 5/16, 5/16 x 3/8, 3/8 x 7/16, 7/16 x 1/2, 1/2 x 9/16, 5/8 x 11/16, 3/4 x 25/32, 13/16 x 7/8"

W1086* - METRIC

Inner: 6 Master: 12

Sizes: 6 x 7, 8 x 9, 10 x 11, 12 x 13, 14 x 15, 16 x 17, 18 x 19, 20 x 22mm

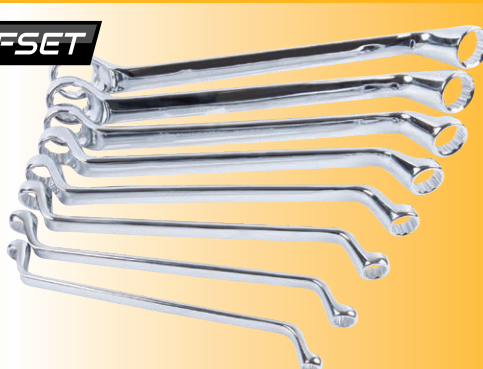

WRENCH SET RACKS

- Durable impact resistant construction
- Comfortable molded handle

W30600* - SAE

Inner: 3 Master: 6

Fits SAE sizes: 1/4, 5/16, 3/8, 7/16, 1/2, 9/16, 5/8, 11/16, 3/4, 13/16, 7/8, 15/16, and 1 in



SAE

METRIC

W30601* - METRIC

Inner: 3 Master: 6

Fits MET sizes: 6, 8, 10, 12, 13, 14, 15, 17, 18, 19, 21, 22, and 24mm



TOOL STORAGE



FENDER BUDDY FLEXIBLE TRAY

- This tray is the perfect size to transport sockets and wrenches right to the project site
- Four small molded pockets for nuts and bolts
- Flexible tray can hold the wire, crimping tool, and the terminal connectors needed for the project
- Soft silicone material grips and molds to anything it sets on and will not damage the surface

W1294*
Inner: 1 Master: 6



ULTRA FLEXIBLE



3-PC TOOL POUCH SET

- Constructed of durable rubber backed polyester material with a sturdy zippered opening
- Features a front mesh insert to view contents and prevent moisture and dirt from accumulating at the bottom of your bag
- The included carabiner and integrated hang loops lets you clip these pouches to your belt loop or tool bag

W88979*
Inner: 12 Master: 48



Pouches measure 5.25" x 7.5" (Red), 6.25" x 7.25" (Blue), 6.75" x 8.5" (Green)

TOOL CADDY PRO

- Our Tool Caddy PRO has dual oversized compartments so you can transport all your tools to the job site
- Built in cell phone holder keeps you phone safe and at hand
- Integrated magnetic tray with hidden compartment underneath, tape measure clip, screwdriver and plier holders
- Built in channel will stabilize pipe, conduit and molding so you can make clean cuts
- SAE and Metric measurements embossed onto side rails for quick measurements

Sold in **MASTER QUANTITIES**



W88995*
Inner: 1 Master: 5

12 IN. OPEN TOP TOOL BAG TOTE

COLLAPSIBLE FOR STORAGE

- Rigid sides and interior panels hold bag open allowing easy access to tools and equipment
- Made of durable polyester fabric construction with built in base pads to protect bottom
- Features 14 external multi-use pockets and 5 internal loops to organize all of your tools and accessories

W88976*
Inner: 1 Master: 6



Tools not included.



14 EXTERNAL POCKETS

12 IN. TOOL BAG

- Tough 600 denier fabric construction
- Heavy duty stitching and bar tacking at stress points
- Wide zipper opening for easy access

REINFORCED BOTTOM



W88985*
Inner: 6 Master: 24

12.5 IN. PLASTIC TOOL BOX

- Heavy-duty box with recessed ergonomic comfort handle
- Removable tray & lid organizers



W54012*
Inner: 1 Master: 16

16 IN. PLASTIC TOOL BOX

- Heavy-duty box with recessed ergonomic comfort handle
- Removable tray & lid organizers



W54016*
Inner: 1 Master: 8

26 IN. STEEL TOOL BOX

- Heavy-duty box with recessed ergonomic comfort handle
- Removable inner tray
- Strong double latch with padlock eyehole



W54026*
Inner: 1 Master: 4

6-PC 2 IN. & 6 IN. SOCKET ADAPTER SET

- Impact grade chrome vanadium steel with rust resistant black phosphate finish
- Ball bearing ensures sockets are securely seated
- 1/4" hex shank with 2" and 6" (50.8 mm and 152.4mm) overall lengths
- Square drive sizes: 1/4, 3/8 and 1/2"
- Transforms your power drill into a power nut/socket driver



NEW

W9032*
Inner: 6 Master: 36

6-PC POWER TOOL ADAPTER SET

- All 3 have built in detent balls to help hold your sockets in place during use
- 6" x 1/4" hex head flex extension bar has free spinning collar and detent ball to hold bits securely in place
- Magnetic 3" x 1/4" Hex drive extension holds onto fasteners, freeing up your hands in tight spaces



W9072*
Inner: 6 Master: 36



3-PC 10 IN. SOCKET ADAPTER SET

- Impact grade chrome vanadium steel with rust resistant black phosphate finish
- Spring loaded ball bearing ensures sockets are securely seated
- 1/4" hex shank with 8-1/2" (216mm) long shank
- Chamfered square drive in 1/4, 3/8 and 1/2" drive sizes
- Transforms your power drill into a power nut/socket driver



W9052*
Inner: 6 Master: 48



IMPACT GRADE

8 IN. SOCKET ADAPTERS

- Transforms your power drill into a power nut/socket driver
- Free spinning collar allows you to maintain a positive grip while fastening
- Durable Cr-V construction with black phosphate finish
- Ball bearing ensures sockets are securely seated

W1381* - 3/8 IN. DR.

Inner: 24 Master: 144

3/8

W1382* - 1/2 IN. DR.

Inner: 24 Master: 144

1/2

While Supplies Last

SOCKET DRIVER

BIT DRIVER

SPINNING COLLAR

3/8 IN. DR. SOCKET ADAPTER SET

- Dual purpose extension: 3/8" square drive adapter and 1/4" hex bit holder
- Transforms your power drill into a power nut/socket driver
- Free spinning collar allows you to maintain a positive grip while fastening
- Durable Cr-V construction with corrosion/oil resistant black phosphate finish
- Retaining ring collar ensures sockets are securely attached

W9037*

Inner: 12 Master: 48

RIVET GUN DRILL ADAPTER

- Tough alloy steel nose and gearing works with aluminum or stainless-steel rivets to achieve professional results
- Works with rivet sizes: 3/32 in. (2.4mm), 1/8 in. (3.2mm), 5/32 in. (4.0mm), and 3/16 in. (4.8mm)
- Specifications: Adapter length: 6.3 in. (160mm), Weight: 0.62 lb. (280g), MAX speed: 1000 RPM, Minimum torque required: 15N.m
- Includes: 1 rivet gun adapter, 2 wrenches, 4 nose pieces



RIVET GUN DRILL ADAPTER

3/32" - 3/16"

1/4"

1/4"

1/4"

1/4"

1/4"

1/4"

1/4"

1/4"

1/4"

1/4"

1/4"

1/4"

1/4"

1/4"

1/4"

1/4"

1/4"

1/4"

1/4"

1/4"

1/4"

1/4"

1/4"

1/4"

1/4"

1/4"

1/4"

1/4"

1/4"

1/4"

1/4"

1/4"

1/4"

1/4"

1/4"

1/4"

1/4"

1/4"

1/4"

1/4"

1/4"

1/4"

1/4"

1/4"

1/4"

1/4"

1/4"

1/4"

1/4"

1/4"

1/4"

1/4"

1/4"

1/4"

3-PC POWER TOOL BRUSH SET

- These cleaning brushes are great for tile, grout, fiberglass, home, auto, boat, and RV interiors
- 3 pc kit contains 2" and 4" round flat brushes and one 3-1/2" dome shaped brush with medium stiffness polypropylene all-purpose bristles
- Standard 1/4" quick connect shaft molded to each brush for secure attachment to your power drill or driver (power tool not included)



Power Tool not included.

W4991*

Inner: 1 Master: 32

30-PC TITANIUM DRILL BIT SET

NEW

- Drill bits are made from #4241 high speed steel (HSS) and coated with Titanium-nitride to reduce heat, keeping the 118-degree split cutting edge sharper, longer
- 4 of the most popular replacement bit sizes included: (3) 1/4", (7) 3/16", (10) 1/8", (10) 1/16" in

W9009*

Inner: 12 Master: 48



63-PC TITANIUM DRILL BIT SET

- These titanium-nitride coated drill bits have a 118 degree cutting head and are made from #4241 High speed steel (HSS) which resist heat for durability
- Included is a hang able storage box which is indexed to help you find the right bit quickly

W9013*

Inner: 6 Master: 24

21 different bit sizes from 1/16 to 3/8 in. included: 1/16, 5/64, 3/32, 7/64, 1/8, 9/64, 5/32, 11/64, 3/16, 13/64, 7/32, 15/64, 1/4, 17/64, 9/32, 19/64, 5/16, 21/64, 11/32, 23/64, 3/8 in. Additional bits: (18) 1/16, (14) 1/8, (6) 3/16, (3) 1/4 in.



EXTERNAL DEBURR BITS

- Quickly repair ends on wheel studs, bolts, and threaded rod by removing burred and damaged ends
- Easily repairs threads in place, eliminating the time and cost of replacing hard-to-find or expensive hardware
- The 3 (W9005) or 5 (W9006) long lasting tungsten carbide cutting blades with a hardness rating between 88-90 HRC are durable enough to use on most metals leaving a clean thread end

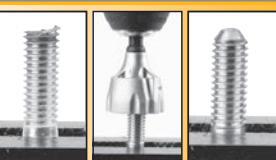

W9005* - 1/8 TO 3/4 IN.

Inner: 6 Master: 48

W9006* - 1/2 TO 1-1/38 IN.

Inner: 6 Master: 36



NEW

102-PC DRILL & DRIVER BIT SET

- Includes 78 of the most popular regular and tamper resistant fastener styles made of impact grade S2 steel and universal 1/4" hex shafts
- Also 24 Titanium Oxide coated 4341 HSS (High speed steel) drill bits with a 118 degree cutting tip
- Patented 2 sided flip case with crystal clear lids so you can easily find the needed bit
- Peg hook hanger tab can be pulled out for hanging or pushed flush into the case for compact storage



W9060*

Inner: 4 Master: 8



253-PC DRIVER & DRILL BIT SET

- This 253pc Driver and Drill bit set Includes the most popular screwdriver bit styles and drill bits styles to handle most any job around the home and shop
- 203 assorted driver bits have 1/4" hex shafts and are made of impact grade chrome vanadium (CrV) steel for strength and durability
- 3" magnetic bit holder will work with all 1/4" bits to securely hold screws in place
- 45 assorted drill bits in 4 different styles for drilling into wood, metal, plastic and masonry



W9080*

Inner: 1 Master: 6



RECHARGEABLE X



500LM STRIP HEADLAMP

- 500LM rechargeable COB strip headlamp
- Uses professional grade licensed COB [Chip-on-Board] technology strips
- Adjustable strap with rear battery pack with power level indicator
- Powered by 3.7V 1800mAh Li-Polymer rechargeable battery (built-in)
- USB-C charge cord included (50 cm)



**500+
LUMENS**

NEW

W2681*
Inner: 8 Master: 48

4-Output Settings: High beam 500 lumens, Medium beam 250 lumens, Low beam 100 lumens, Safe Mode - 23 lumens



550LM STRIP & SPOT HEADLAMP

- 550LM rechargeable COB strip and LED spot headlamp
- Uses professional grade licensed COB [Chip-on-Board] technology strip
- Adjustable strap with rear battery pack with power level indicator
- Powered by 3.7V 1800mAh Li-Polymer rechargeable battery (built-in)
- USB-C charge cord included (50 cm)

**550
LUMENS**



NEW

W2682*
Inner: 8 Master: 48
5-Output Settings: COB + Spot 550 lumens, Spot 200 lumens, High COB 400 lumens, Low COB 200 lumens, Safe COB 23 lumens

450+LM LI-ION DUAL BEAM HEADLAMP

- Flexible silicone band and LED board provide over 200° of wide angle light
- Dual 21+1 LED light sources, each with high/low output provide as little as 50lm for low light needs, all the way up to 450 lumens
- 1200mah polymer rechargeable battery, with power indicator light, USB-C charging port and cable
- Flexible operation features touch-free sensor mode



**450+
LUMENS**

**TOUCH-FREE
ON/OFF**

**ULTRA
LIGHTWEIGHT**



W2676*
Inner: 10 Master: 60
Specifications: Spot-Low: 51.5lm, 6.5 hr runtime; High: 123.3lm, 4.5 hr runtime; Beam-Low: 139.5lm, 3.5 hr runtime; High: 465.9lm, 2.5 hr runtime; charging time: 3 hr

COMPACT FLASHLIGHTS

- Uses professional grade lifetime Cree XTE LEDs
- Black anodized aluminum alloy steel construction with IPX4 water resistance
- 4-Output Settings: Turbo beam: 20 second run time, High beam: 2.5 hour run time, Low beam: 5.5 hour run time, Safe mode: 15 hour run time
- Powered by 3.7V 18350 800mAh Lithium-Ion battery with over discharge protection
- USB magnetic charge cable included

NEW



**COMPACT
DESIGN**



W2678* - 1200 LM
Inner: 8 Master: 48

**1200+
LUMENS**

W2679* - 2000 LM
Inner: 8 Master: 48

**2000+
LUMENS**



NEW 350+ LM LI-ION DUO-LIGHT

- Duo-light features flashlight with side-emitting work light for a wide flood beam of light
- Adjustable DuoFocus beam goes from spot to flood
- Super bright Cree and Seoul LEDs never need replacing
- Built-in 14500, 600mAh capacity, li-ion battery (included)

W2677*
Inner: 6 Master: 24

**350+
LUMENS**



COMPACT LED LI-ION WORK LIGHT

- Features high output wide angle LEDs for a flood of light
- Rare earth magnet on back for hands free work
- Flip-up hook for added versatility
- Specifications: 320 Lumens, 3 hr run time, 1000mAh, 3.7V
- Built-in rechargeable lithium ion battery - includes micro USB charging cable

**Sold in
INNER
QUANTITIES**

**300+
LUMENS**



W2675*
Inner: 8 Master: 96



150LM LI-ION LIGHTED PEN

- Retractable ball point pen, wide angle area light, and power button also works as a stylus
- Integrated LED area light delivers up to 150 lumens, enough to write in the dark
- Built-in rechargeable li-ion battery provides an hour of runtime
- Double ended pocket clip for storage or hands-free use

**150+
LUMENS**



**DOUBLES
AS STYLIST**

W2674*
Inner: 6 Master: 48

2-PK REPLACEMENT CARTRIDGES

W2674-1*
Inner: 24 Master: 432

Includes two refills to help extend the life of your W2674 LED pen



UNDERHOOD

WORK LIGHT X

15 IN. FLEXIBLE LIGHT BAR*

- Innovative design spans hoods over 6 feet wide and wraps up for compact storage
- 15-Inch flexible light bar provides a variety of uses and allows light to be directed right where you need it
- 60 Wide angle LEDs provide over 1000 lumens of flood light
- Adjustable elastic strap fits almost any size hood
- Rubber padded hooks prevent scratching or denting
- Powered by dual 18650 2200mAh Li-Ion batteries (included) and USB charging cable

FITS ALMOST ANY SIZE HOOD



SPANS HOODS OVER 6 FEET WIDE

SCAN FOR VIDEO



1000+ LUMENS



W2673*
Inner: 1 Master: 20

Specifications: 1071lm, 2.5hr runtime on high; 500lm, 4hr runtime on medium; 300lm, 5hr runtime on low.

150LM LI-ION PIVOTING THIN WORK LIGHT

- Double hinged light bar provides 360 degrees of light for precise illumination
- Compact design with thin, low profile light bar for access in confined areas
- Features additional light at the tip, magnetic base, swivel hook and pocket clip
- Integrated 14500 lithium-ion rechargeable battery (USB cord included)

NEW



UNIQUE DOUBLE RINGED PIVOTING ACTION

150+ LUMENS



W2646*

Inner: 12 Master: 72
Specifications: 150lm area light, 30lm spot light, 4-5 hour runtime, 3 hour charging time

30 LED SLIM WORK LIGHT

- Variable output dial adjust light output from 150 to over 600 lumens
- Swivel hook and removable 360° swivel magnetic base for hands free use
- Comfortable lightweight housing with ergonomic grip
- Built-in rechargeable lithium ion 18650 battery and charging cable

W2231*

Inner: 10 Master: 50
Specifications: Run time 2.5h (high), 10h (low); Charge time: ~2h, Input: 5V 1A, Battery: 3.7V DC, 2000mAh; USB cable length: 80cm

600+ LUMENS



FOLDING LI-ION 700LM LIGHT

- 180 degree pivoting light bar shines up to 700lm of light
- High output area light and spotlight in one tool
- Swivel hook and magnetic base for hands free use
- High impact housing with ergonomic rubber grip
- Built-in rechargeable lithium ion 18650 battery and charging cable

W2665*

Inner: 6 Master: 24
Specifications: 3-hour run time (high), 5-hour run time (low); Charge time: ~2h, Input: 5V 1A, Battery: 3.7V DC, 2000mAh



White Supplies Last

700+ LUMENS



DRY CELL X

LI-ION RECHARGE BATTERIES

- No memory effect - recharge up to 500 times whether fully or partially drained
- Built-in circuit protection to ensure proper venting, prevent overcharge or discharge

W2659B* - 16340 CELL

Inner: 6 Master: 48
Standard replacement 16340 cell with 700mAh capacity; Voltage: 3.7V; 2.59Wh. For use with PT Power model W2659.

White Supplies Last

W2674B* - 10280 CELL

Inner: 6 Master: 48
Standard replacement 10280 cell with 150mAh capacity; Voltage: 3.7V; 0.56Wh. For use with PT Power model W2674.

W2655B* - 18650 CELL

Inner: 6 Master: 48
Standard replacement 18650 cell with 2600mAh capacity; Voltage: 3.7V

W2669B* - 26650 CELL

Inner: 12 Master: 48
Replacement 26650 cell with 4000mAh capacity; Voltage: 3.7V; 14.8Wh



500+LM 3AA FOLDING THIN WORK LIGHT

- High output area light and spotlight in one tool
- Impact resistant handle with comfortable rubber grip with magnetic base for hands free use
- Produces over 500 lumens of bright white light
- Light bar adjusts 120° for precise illumination

NEW



W2418*

Inner: 5 Master: 20
Specifications: Area light: 430 lm, 1.5H runtime, 50m beam distance on high; 180 lm, 3H runtime, 20m beam distance on low. Spot light: 70 lm, 8H runtime



500+ LUMENS



POWERHILT™ NON-SLIP RUBBER GRIP



120 VOLT X

120V STEEL CAGE PRO DROP LIGHT

- Reflective galvanized metal lamp shield with swivel hang hook
- Impact resistant handle with comfortable non-slip rubber grip
- Standard E26 light socket uses up to 75 watt incandescent bulb or LED equivalent
- 25ft grounded cord with built-in 120V outlet (500W MAX)

W2243 *
Inner: 4 Master: 16

NEW



120V 1000LM WORK LIGHT

- Ultra high output of more than 1150 lumens
- SMD LED technology means unit stays cool enough to touch
- Wide angle LEDs distribute large flood beam of light
- 5 foot 18GA grounded power cable
- cETL listed 5008747



1150+
LUMENS

W2230 *
Inner: 1 Master: 8



1000LM DIRECT PLUG LED DROP LIGHT

- All the durability of a traditional drop light with the efficiency of LED technology
- Produces over 1000 lumens of bright white light
- Impact resistant handle with non-slip rubber grip and base hook
- Powder coated metal lamp shield with swivel hang hook
- Built-in 120V outlet (600W MAX)

W2244 *
Inner: 4 Master: 16

POWERHILT™ NON-SLIP RUBBER GRIP

1000+
LUMENS



ROUGH SERVICE LED LIGHT BULBS

- Energy efficient replacement to standard incandescent or CFL light bulbs
- Fits most standard A21/E26 type sockets
- Specifications: input voltage 110-265V AC; CRI 80Ra; 2700K color temperature; 50-60Hz; minimum lifetime of 3600 hours
- Instant on, no warm up time and dimmable

W2283 * - 1500 LM
Inner: 10 Master: 50

W2282 * - 1200 LM
Inner: 10 Master: 50



120Volt

120V 6500LM WORK LIGHT W/TRIPOD STAND

- Includes 120V E26 threaded ceiling light, 120V adapter with 12ft cord, and 3-section telescoping tripod stand
- Energy efficient replacement to high output halogen, halide, sodium or other incandescent lights
- Uses the same energy as a 60W incandescent light bulb, but produces nearly 8 times the amount of light

W2286 *
Inner: 1 Master: 4

6500+
LUMENS

120Volt

6500LM 120V LED CEILING LIGHT

- Energy efficient replacement to high output halogen, halide, sodium or other incandescent lights
- Die cast cooling blades dissipate heat to provide optimal output

W2284 *
Inner: 1 Master: 18



8-IN-1 MULTI-TAP OUTLET

- 8-in-1 power strip features 4 grounded 120-volt outlets 3 standard USB ports and 1 USB-C port
- Built-in smart chip automatically senses your connected devices and delivers appropriate current
- USB-C port delivers up to 5V/3A max (15W), and 30% faster charging
- Fire-retardant casing, 5 ft. (1.5m), 14AWG braided copper power cord, and overload shut-off switch

W2266 *
Inner: 10 Master: 30

NEW



120Volt

1000LM WORKBENCH POWER STATION

- This versatile power station is commercial grade with lighted on/off switches and built in circuit breaker, instantly adds 120v electrical outlets, USB ports and additional lighting to your work space
- 6 commercial quality outlets are copper coated with riveted construction
- 2 LED lights put out a total of 1000 lumens of 6000K daylight
- 2x USB Charging ports provide 5v@2.4 amp on each (3.4A total max) with over current protection
- 6 ft - 14/3 AWG cord has heavy rubber coating and grounded 3 prong plug

W2279 *
Inner: 1 Master: 4

NEW



1000+
LUMENS

120Volt

16GA EXTENSION CORDS

- Vinyl covering protects against moisture, abrasion, and direct sunlight and is suitable indoor/outdoor use
- Three-prong plug, grounded for safety
- cUL listed E218475

W2270 * - 25 FT.
Inner: 3 Master: 12

W2271 * - 50 FT.
Inner: 3 Master: 12



White Supplies Last

7 IN. WIRELESS LIGHT BAR

- Professional grade lifetime Osram SMD
- Powered By 4-AAA batteries
- 120° Light angle for maximum area lumination
- Motion sensor feature shuts light on/off after 28 seconds within 10' radius
- 3M® adhesive to attach/mount to most smooth, level surfaces
- Motion ON/OFF, 65 lumens
- Wireless Unit- No Wires, No Tools & No Mess ! Install in Minutes



MOTION SENSOR



MAGNETIC STRIP

720*
Inner: 12 Master: 72

LI-ION UNDER CABINET LIGHTS

- Professional grade lifetime SMD
- 120° Light angle for maximum area lumination
- Motion sensor feature shuts light on/off after 25 seconds within 10' radius
- Easy to install, unit has magnetic base & Adhesive to attach/mount to most smooth, level surfaces
- Powered by rechargeable 3.7V Li-poly battery, micro USB charger included
- 3 output settings : 1. Auto (Motion) 2. Instant On 3. Instant Off



MOTION SENSOR



MAGNETIC BASE



ON/OFF/AUTO



REMOVABLE MOUNTING CLIPS (x2)

MICRO-USB CHARGER



NO TOOLS NEEDED

715* - 8.5 IN.
Inner: 6 Master: 48



WIRELESS BULB LIGHT W/REMOTE

- The world's first grab and go light bulb, because it actually a flashlight cleverly disguised as a light bulb
- Energy efficient & professional grade licensed COB tech strips, stays cool to the touch
- Bulb can easily be mounted with 2 small screws (not included) or use the double sided adhesive for a permanent placement
- Powered by 3-AAA batteries (included)

200 LUMENS

WIRELESS RANGE
33 FT



713*
Inner: 6 Master: 24

13 LM LED FLAMING TORCH

- Professional Grade Lifetime Fire core LED
- 3 Output Settings: Steady High Beam - 25 lumens; Gradual Low Beam - 3-10 lumens; Flicker Ring Light - 13 lumens
- IPX4 water resistant ABS housing
- Flip-out hang hooks for added versatility
- Powered by (3) AAA batteries included

435*
Inner: 4 Master: 24



While Supplies Last

2-PK LED PATHWAY LIGHTS

- Uses professional grade lifetime SMD bulbs
- Solar powered charging
- Weatherproof water tight seal, made of durable ABS plastic and Polypropylene
- Automatic daytime shut-off
- (4) Removable ground spikes

COBBLESTONE 354*
Inner: 6 Master: 24

Sold in **INNER QUANTITIES**



SANDSTONE 356*
Inner: 6 Master: 24

SOLAR MOTION SENSE LIGHT

- Uses professional grade lifetime licensed COB technology strips
- 8-10 hr solar charging time
- Powered by (1) 18650 3.7v 1800mAh lithium ion rechargeable battery, included



MOTION SENSOR



900 LUMENS

702* - 900 LM
Inner: 6 Master: 24

701* - 460 LM
Inner: 6 Master: 24

460 LUMENS



Solar Powered & Motion Activated

- ✓ No Tools Needed
- ✓ Weather-Proof
- ✓ Easy Install

460 LUMENS

1000 LUMEN RECHARGE LANTERN

- Uses licensed COB technology strips
- USB & Micro USB port for charging, cord included. Can also be used to charge smart devices including phone, tablets, etc
- 3 functions: Hi 1000 lumens, Med 750 lumens, Low 500 lumens
- Powered by (2) 18650 1800 mAh rechargeable li-ion batteries (included)

403*
Inner: 1 Master: 9



COLLAPSIBLE HANG HOOK

1000 LUMENS



*California Residents Prop 65 warnings see page 36.

SPECIALTY TOOLS

EXHAUST TAILPIPE CUTTER

- Use to cut exhaust pipes 3/4 in. to 3-3/4 in. diameter
- 15 hardened steel blades for quick, efficient cutting
- Works well in confined hard-to-reach places, needing only a quarter turn to work
- Cut tailpipe and exhausts on or off the vehicle cleanly

W80689 *
Inner: 10 Master: 10

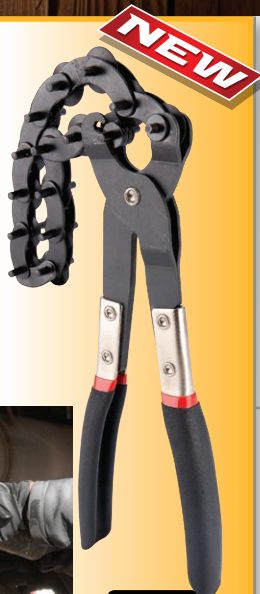

14 HARDENED STEEL BLADES

WINDSHIELD NOZZLE CLEANER

- Use to clear obstructions and realign the windshield washer spray nozzle
- The different tips easily pierces, adjust or remove debris that causing blockage or aim
- Knurled body provides precision grip and control
- The rubber O-Rings and screw on end caps keep the needle points covered and clean

W86558 *
Inner: 48 Master: 288



9-PC MASTER TRIPLE SQUARE BIT SET

- Nine Piece Triple Square (12 point) Bits to Fit 4, 5, 6, 8, 10, 12, 14, 16 and 18mm Sizes
- Use on Triple Square, or Serrated fastener found on Asian and European vehicles
- Used on head bolts, brake callipers bolts, door handle and hinge fasteners, axle, and flywheel bolts
- The 4 and 5mm bits have a 5/16 hex shaft. The 6, 8, 10 and 12mm bits have 1/2 hex shaft. The 14 and 16mm bits have 17mm hex shaft, and the 18mm bit has a 3/4 hex shaft
- The three largest sizes are designed to fit tamper-proof applications

W86024 *
Inner: 6 Master: 24



NEW

BRAKE FLUID AND TIRE PRESSURE GAUGE

- Unique 2 in 1 tool combines automotive brake fluid tester and tire gauge to check the pressure
- Displays your digital tire pressure on an easy-to-read backlit LCD screen
- Check brake fluid quality, providing the percentage of water in the braking system
- Accurately test DOT 3, DOT 4, and DOT 5.1 brake fluid



W183 *
Inner: 10 Master: 100

NEW

QUICK CONNECTOR CLIP TOOL

- For releasing connections on fuel lines during maintenance or when replacing fuel filters
- Compact palm size design allows you to compress the quick disconnect lugs in tight confined areas
- Cushion grip can be angled to better access the fitting or connector
- Widely used on hoses with snap connectors found on, VW, Audi, Mercedes, Fiat, GM, Ford, and others

W83116 *
Inner: 6 Master: 72



NEW

UP TO 1-3/4"
(UP TO 44.5 mm)

2-9/64 IN. BALL JOINT SOCKET

- Removes and installs the screw-in type ball joints used on mid-size, rear-wheel drive Chrysler cars
- Fits the 2-9/64 inch ball joints used on Chrysler/Dodge/Ram light trucks and vans
- Machined from high-strength steel for durability and accepts a standard 1/2 in. drive breaker bar

W83001 * - 2-9/64 IN.
Inner: 5 Master: 20

W83003 * - 1-59/64 IN.
Inner: 5 Master: 20



NEW

18-PC BRAKE CALIPER SOCKET SET

- Specialty brake caliper bits and sockets needed to service today's Domestic, Euro and Asian vehicles
- Complete coverage for most brake caliper applications in one convenient set
- Heat treated chrome vanadium, and chrome molly construction

W86025 *
Inner: 1 Master: 10



INCLUDES BLOW MOLD CASE

NEW

XL C-FRAME BALL JOINT TOOL

- Ideal for removing larger ball joints on press-fit ball joints found in pick-up trucks and SUV's
- Service Toyota Tacoma, Tundra, Chevrolet 2500-3500, Tahoe, Ram 2500-3500, and Ford F350-F551
- Our heavy duty ball joint press is compatible with most other brands of sleeve adapters
- Includes both long and short drive screws to maintain a shorter overall working length

W89306 *
Inner: 1 Master: 2



NEW

EXTRA LARGE

1 INCH

1/4 IN. BEAM DEFLECTION TORQUE WRENCH

- 0-80 in/lbs clockwise or counterclockwise measurement
- Ball type handles that localize force, better ensuring accuracy
- Deflection beam wrenches do not wear or fatigue over the lifetime of the tool, insuring better accuracy
- Directly measure a variety of torque values when tightening fasteners

M195 *
Inner: 6 Master: 24



80 IN./LBS. MAXIMUM TORQUE
0-80 WORKING TORQUE

3/8 IN. DR. TORQUE WRENCH

- Dual scale measurement adjustments in both Inch-Pound and Newton meter
- Patented torque adjusting lock/unlock collar
- Internal torque mechanism is manufactured of high grade spring steel
- Returning wrench to lowest setting after each job ensures accuracy and long life

10-100 FT/LBS TORQUE RANGE



M198 *
Inner: 1 Master: 6



2 IN 1 DRAIN PAN TOOL CADDY

- Oil drain pan and mobile tool caddy, two tools in one
- Use together when changing oil, or separately keeping your tools organized while under the car
- Unique splash guard and oil filter drain post on an 8 liter drain pan
- Oil drain pan is designed to cradle into the tool caddy making the pan mobile, easy to position

W4074*

Inner: 1 Master: 1



NEW

TOOL CADDY



DRAIN PAN

BUILT-IN FILTER DRAIN POST

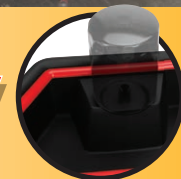

Tools not included.

SMALL ENGINE OIL CHANGE KIT

- Extract used oil from small 4 stroke engines including mowers, weed whackers, blowers, and more
- Oil suction syringe extracts used oil through the enclosed 12 inch clear suction hose
- Empty the used oil into the temporary oil container for simple and hassle free oil changes
- Enclosed funnel is the perfect size to fit small oil fill ports on most 4 stroke equipment

W4075*

Inner: 1 Master: 20



NEW

WORKS WITH MOST 4 STROKE ENGINES



ANGLED ADJUSTING FILTER PLIERS

- 30° Offset angled jaws allow for more clearance when loosening a filter
- Self-adjusting spring tension automatically adjusts to the proper size
- Wide jaw design offers a wide range capacity from 2-5 inches (51-127mm)



W54315*

Inner: 6 Master: 36

HIGH VOLUME LEVER GREASE GUN

- Three times the grease output per stroke
- Durable cast iron pump head, dual piston design provides high volume long lasting performance
- A dual grease inlet ensures no loss of prime even in extreme cold weather
- Rigid delivery tube and heavy duty push-on hydraulic 4-jaw coupler

DUAL PISTON: 3X THE GREASE PER STROKE

W54296*

Inner: 1 Master: 12



Develops up to 10,000 PSI to deliver 1 oz of grease per 7 strokes

18 VOLT CORDLESS GREASE GUN

- Profession quality completely cordless grease gun
- High quality blow molded storage case
- 2 powerful 18 volt NI-CAD batteries and charger included
- W11046 Replacement Battery

INCLUDES BLOW MOLD CASE

W50048*

Inner: 1 Master: 4



QUICK-LOCK GREASE COUPLER

- Well-designed high-pressure coupler delivers lubrication, forcing it into bearings and joints
- Simply turn the knurled swivel handle with a finger
- Four hardened spring steel jaws and a high-quality sealing gasket provide a leak-proof connection

W54174*

Inner: 12 Master: 48



NEW

SPILL PROOF COOLANT FUNNEL KIT

- Easily used to properly refill automotive cooling systems without the chance of spilling
- Eliminates trapped air pockets which causes erratic cooling system and heater performance
- Better control when adding coolant preventing overflow onto belts and other engine components
- Includes threaded cap adapters for newer GM and Ford threaded style radiator openings
- Contents: 5-inch straight extension, two 1/4-inch 45 degree elbows, 5 cap adapters, 4 caps, stopper, funnel, and lid

W89740*

Inner: 1 Master: 12



SPILL PROOF

NEW



CLEAR VIEW GREASE GUNS

- Unique window cut-outs for better identification of grease types
- Variable stroke enables the operator to work in tight and narrow spaces
- Built-in air pocket release valve for convenient release of trapped air

W54294* - PISTOL GRIP

Inner: 1 Master: 12

- 12 in. flexible hose with coupler

W54293* - LEVER ACTION

Inner: 1 Master: 12



Specs: Working pressure: 3000 psi. Develops 5000 psi. Delivers: 1 oz. / 40 strokes. Capacity: 14 oz. / 400 c.c.

BATTERY SERVICE

BATTERY JUMPER CABLES

- Red/black PVC-coated insulated clamps for easy identification
- Tangle-free rubber coated cables
- All weather use

20 FT. 2 GA

- Commercial duty for tractors, semis, buses, and RVs
- High tension parrot style clamps
- 2 Gauge, 20 Foot, 600 AMP/800 Peak

W1669*
Inner: 1 Master: 4



10FT 4GA LIGHTED JUMPER CABLES

- Clamps feature integrated LEDs to illuminate your working area at night or in a dark garage
- Red/black non-conductive clamps for easy polarity identification with tangle-free rubber coated cables
- Standard duty for large cars and mid-size pick-up trucks and SUVs
- 4 Gauge, 10 Foot, 220 AMP/400 Peak



W1675*
Inner: 1 Master: 6

20 FT. 4 GA COPPER

- Heavy duty for full size trucks, vans and SUV's
- Heavy duty copper jaw clamps
- 4 Gauge, 20 Foot, 500 AMP/600 AMP Peak
- 100% Copper Cable

W1667*
Inner: 1 Master: 6



100% COPPER

20 FT. 4 GA

- Heavy duty for full size trucks, vans and SUV's
- Heavy duty copper jaw clamps
- 4 Gauge, 20 Foot, 500 AMP/600 Peak

W1673*
Inner: 1 Master: 6



16 FT. 6 GA

- Standard duty for large cars and mid-size pick-up trucks and SUV's
- Heavy duty copper jaw clamps
- 6 Gauge, 16 Foot, 400 AMP/500 Peak

W1672*
Inner: 1 Master: 6



12 FT. 8 GA

- Medium duty for passenger light cars & pick-up trucks
- Heavy duty copper jaw clamps
- 8 Gauge, 12 Foot, 250 AMP/300 Peak

W1671*
Inner: 6 Master: 12



12 FT. 10 GA

- Light duty for compact vehicles & motorcycles
- Heavy duty copper jaw clamps
- 10 Gauge, 12 Foot, 150 AMP/250 Peak

W1670*
Inner: 6 Master: 12



PORTABLE JUMP STARTER

- 900 Peak Amps/400 Cranking Amp Jump Starter
- 300 PSI Air Compressor/Inflator for pumping up tires and inflating rafts, balls, air mattresses & other inflatables
- Reverse polarity warning light and beep signal help prevent damaging unit or battery
- Two 12V Power Adapter Outlets
- Automatic shut-off prevents over charging the battery
- Equipped with 12 Volt, 12AH Sealed Lead Acid Battery

W1665*
Inner: 1 Master: 2



PERFECT FOR EMERGENCIES

900
PEAK AMP



ROADSIDE SAFETY TOOL KIT

- Includes: jumper cables, pliers, screwdrivers, and more
- Contents: 8 ft Jumper Cables, Flashlight, Pencil Tire Gauge, Knit Gloves, Whistle, 10pc Fuse and Terminal Kit, 6 in. Slip Joint Pliers, #2 Philips Screwdriver, 1/4 in. Slotted Screwdriver
- 9 1/4 in. Drive Sockets: 1/4, 5/16, 3/8, 7/16 in., 4, 6, 8, 10, 12mm, 1/4 in. Drive Spinner Handle, 3/4 in. x 25 ft Electrical Tape
- 2AA Batteries included



W1556*
Inner: 1 Master: 10



3-PK DOT WARNING TRIANGLE

- This D.O.T. approved warning triangle set is ideal for unexpected roadside emergencies
- Convenient travel case keeps all three triangles together and clean until needed
- Each triangle weighs 2.9 pounds for stability in windy conditions
- An open Triangle measures 17.5" long / wide and 17.2" tall

W1498*
Inner: 1 Master: 4



D.O.T. APPROVED



Limited to stock on hand.

3-PK LED SAFETY ROAD FLARES

- Make others aware of your vehicle even if the vehicle battery is dead
- Tough plastic construction is compact and lightweight
- 12 bright red LEDs last up to 50 hours
- Swivel hook and magnet on back for hands free use



SWIVEL HOOK ON BACK

W2343*
Inner: 4 Master: 32



EMERGENCY TRACTION MAT

- Emergency traction when your vehicle is stuck in snow, ice, mud or sandy conditions
- Best alternative for tire chains and easier to use, simply place it under your tires and drive up smoothly
- Flexible heavy duty plastic, strong metal hinges, and raised nubs for superior traction
- Comes as a set of 2 traction mats in safety yellow, 38 inches long x 7 inches wide

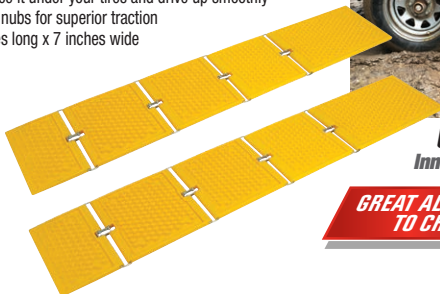

W41003*
Inner: 1 Master: 4

GREAT ALTERNATIVE TO CHAINS

LOCKING LUG NUT MASTER KEY SET

- 16 different key shapes to fit a wide variety of stock and after-market wheel locking lug nuts
- Ensure you have the special key when it's time to change brake pads or rotate the tires
- Double hex-head design allows them to be used with both 13/16 and 7/8 in. lug or combo wrench
- Thin walls and extra-long helps protect the wheel during use to prevent nicks and scratches
- Made of heat-treated chrome vanadium steel for a lifetime of reliable use



NEW

INCLUDES APPLICATION GUIDE

M994*
Inner: 1 Master: 5

Includes Spline Style Keys: 5-spline, 6-spline, 7-spline, and 12-spline. Hex Keys: 9/16-inch, 12mm, 12mm fluted, and 15mm. Star Keys: 8-point, 9-point, 10-point

12 VOLT COMPACT TIRE INFLATOR

- Plugs into 12-Volt Accessory Outlet
- Includes Two Nozzle Adapters and Sport Needle
- Great for Tires, Toys and Sporting Goods
- 10 Ft. Power Cord
- 18 in. Hose Length with Universal Valve Adapter
- High output 150 PSI motor



60399*
Inner: 1 Master: 20



SAE

COLLAPSIBLE

METRIC



W5* *While Supplies Last*
Inner: 2 Master: 8

Includes 11/16 + 3/4 and 13/16 + 15/16" double ended sockets

W6*
Inner: 2 Master: 8

Includes 17 + 19mm and 21 + 23mm double ended sockets

BREAKDOWN LUG WRENCHES

- Full size lug wrench breaks down into two parts for compact storage
- Two position center rod allows for applying added torque to those really tight lug nuts
- Heavy duty heat treated steel with rust resistant chrome plated finish
- Nylon storage pouch to keep everything together
- Free spinning handle with push button release

W9206*
Inner: 8 Master: 96



12 VOLT HEAVY DUTY TIRE INFLATOR

- Inflates Standard Car Tire in 3 Minutes (P195/65 R15 to 35 PSI)
- Powerful 12 Volt, 150 PSI Compressor
- Plugs into 12 Volt Accessory Outlet
- Canvas Bag for Storage
- Bright Light for Emergencies
- Accurate, Easy-to-Read Pressure Gauge
- Sport Ball and Raft Inflator Adapters Included



Inflates in under 3 minutes*

*Performance based upon 175/70 R13 from 0 to 30 PSI.



60404*
Inner: 1 Master: 8

*California Residents Prop 65 warnings see page 36.

EQUIPMENT

3-TON RAPID LIFT JACK

- Dual piston rapid lift, raises most vehicles with just 3-1/2 pumps
- Precision-welded steel construction, with powder coat finish, and rust-resistant hardware
- Removable saddle, adapts quickly to other lifting accessories
- Lift capacity of up to 6000 lb., and a lift range of 3-1/4 in. to 20 in
- 45-1/2 in. long handle with a foam sleeve to protect the vehicle's side panel from scratches



3-1/4 IN. PROFILE



DUAL PISTON



SWIVEL CASTERS



PADDED HANDLE



W1626*
Inner: 1 Master: 1



NEW

RAPID LIFT



2 TON TROLLEY JACK & STAND

- Jack features 4,000 lb. capacity, maximum height 13", swivel casters for easy positioning
- Heavy duty steel lifting arm
- Lightweight for fast positioning
- Tough enamel finish
- Jack stands feature ratchet style for easy adjustment, 10 3/8" to 16 3/8" range and 10 Lock safe settings

4000 lb.
CAPACITY

W1605*
Inner: 1 Master: 1



2 TON COMPACT TROLLEY JACK

- 4,000 lb capacity
- Maximum height 13"
- Swivel casters for easy positioning

4000 lb.
CAPACITY



W1606*
Inner: 1 Master: 1



2.5 TON JACK

- 5 to 15 1/2" lift range
- Swivel casters for easy positioning
- Durable flanged steel frame
- Great for cars and light duty trucks

5000 lb.
CAPACITY



W1640*
Inner: 1 Master: 1

2-1/4 TON TROLLEY JACK BLOW CASE

- 4,500 lb capacity
- Steel lifting saddle with 360 degree swivel
- Clean and easy storage with included blow molded plastic case

INCLUDES BLOW MOLD CASE



W1611*
Inner: 1 Master: 1



4500 lb.
CAPACITY

MOVEABLE STORAGE



SLIDE OUT DRAWER



BUILT-IN TOOL BAR



ROLLING STORAGE GARAGE SEAT

- Ideal companion for cleaning and detailing work, maintenance, repair, and other common vehicle service jobs
- Injection molded body reinforced with rectangular steel supports extending beyond the seat to provide maximum strength and stability
- Two large integrated side storage trays, oversized removable storage drawer, and three removable side trays provide room for all your tools, cans, bottles, rags, parts, and other gear
- Includes two movable trays that can go in any of the six slots on all three sides of the cart

NEW

300 lb.
LOAD CAPACITY



3 MOVABLE TOOL TRAYS



W85035*
Inner: 1 Master: 1

ENDLESS CONFIGURATIONS WITH 7 TRAY LOCATIONS

40 IN. PLASTIC CREEPER W/6 CASTER

- Contoured shape for comfort and easy movement
- Casters swivel 360 degrees
- Blow molded base built-in storage tray
- Oil and water resistant wheels
- Fully padded headrest



40 IN. PLASTIC CREEPER with 6 Casters

Sold in **MASTER QUANTITIES**



NEW

300 lb.
LOAD CAPACITY

W85006BULK*
Inner: 1 Master: 6

36 IN. 6 CASTER CREEPER

- Six shielded 2-1/2" (63.5mm) swivel casters allow easy 360° movement and added stability
- Low profile design provides improved clearance
- Powder coated heavy-duty tubular steel frame
- Fully padded deck with cushion headrest



350 lb.
LOAD CAPACITY



NEW

W85015*
Inner: 1 Master: 1

CREEPER SEAT TOOL BOX

- Reinforced seat supports up to 350 lbs
- 3-drawer tool box with roller bearing slides
- Two folding tool trays with magnetic pads
- Vinyl padded seat cushion for maximum comfort and support
- 2-1/2 in. polyvinyl chloride full bearing casters for smooth movement



CREEPER SEAT TOOL BOX
3 Drawers
350 lb. LOAD CAPACITY



350 lb.
LOAD CAPACITY

W85025*
Inner: 1 Master: 1

REAR TOOL RACK



Tools not included.



CREEPER SEAT W/STORAGE

- Flip top tool chest with two ball bearing sliding drawers provide a total of 790 cubic inches of storage
- Comfortable vinyl padded cushion and reinforced seat support up to 350 lbs
- Dual side trays provide additional storage for pliers, screwdrivers and other tools
- 2-1/2 inch full bearing casters

W85024*
Inner: 1 Master: 1

350 lb.
LOAD CAPACITY



Tools not included.

SIDE TOOL RACK

HIGH TOP ADJUSTABLE CREEPER

- Helps the tech increase productivity safely working from the top side of the engine compartment
- An over the engine workstation with an 18 x 12 inch, (45.7 x 30.5cm), padded deck
- Provides added comfort to the tech, while working on raised vehicles for a longer period of time
- Four swivel casters, two locking to secure the creeper into position

W85038*
Inner: 1 Master: 1

400 lb.
LOAD CAPACITY



FOLDS UP FOR COMPACT STORAGE



45" - 66"
(20-50 mm)

PNEUMATIC BAR STOOL WITH SWIVEL SEAT

- Pneumatic action adjusts seat height from 26" to 32" quickly and easily
- 14" diameter synthetic leather foam padded seat with 360° swivel
- Heavy duty steel tubing frame with matte black powder coated finish
- Wide foot stool base comes pre-assembled



W85011*
Inner: 1 Master: 1

26" - 32"



330 lb.
LOAD CAPACITY

BIG TOP PNEUMATIC ROLLING SHOP STOOL

- Pneumatic action adjusts seat height from 19 to 24 inches (480 to 610mm) quickly and easily
- Extra-wide powder coated 5-point frame and foot rest with durable crinkle finish
- Five hooded dual-caster swivel wheels for easy maneuverability

300 lb.
LOAD CAPACITY

W85033*
Inner: 1 Master: 4



SNOWMOBILE DOLLY

- 1500lb Capacity
- Heavy duty 2" casters
- Rubber covered top for secure moving



1500 lb.
CAPACITY



W41061*
Inner: 1 Master: 1

STORAGE

ROLLING TOOL CADDY

- Provides easy mobile access to your tools while working under vehicles or in confined spaces
- Keeps your tools organized within arm's reach
- Large rolling tray is about 18 inches across and features 5 compartments; 2 large and 3 small
- Integrated steel plate for magnetic tools such as a parts tray, work light or socket rail



W85032 *
Inner: 1 Master: 6

Tools not included.

POLY SERVICE CART

- Easy Rolling Utility cart with upper and lower trays
- 2 shelf utility cart holds up to 500lbs total but is light weight and maneuverable
- Industrial duty polypropylene construction won't rust, dent or chip
- 5" Diameter non marring casters, (two locked and two swivel)
- Tool utility cart has tool storage and cup holder on the handle

W53991 *
Inner: 1 Master: 1

HANDY PAPER TOWEL RACK



500 lb.
LOAD CAPACITY



3 SHELF UTILITY CART WITH DRAWER

- Four swivel casters, plus two locking casters
- Organizer shelf with bins
- Shelf with storage drawer
- Two 23 1/2" x 16" tool trays
- Foam drawer and tray liner
- Assembled Dimensions: 16 in. deep, 24 in. wide and stands 31 in. tall

350 lb.
LOAD CAPACITY

W54006 *
Inner: 1 Master: 1



INTERLOCKING STORAGE

- Interlocking bin design can be mounted vertically or horizontally - Stack multiple bins or combine with any of our other models
- Transparent drawers for quick identification of drawer contents
- Impact resistant polypropylene construction
- Drawer catches prevent accidental drawer tip out

W5910 * - 2 DRAWER
Inner: 1 Master: 6

W5911 * - 4 DRAWER
Inner: 1 Master: 6

MIX & MATCH!
Connect using side/top channels



WALL MOUNT NOTCHES



KEEP YOUR SHOP ORGANIZED

12 DRAWER W5912 *
Inner: 1 Master: 6

12-PC WALL MOUNT BIN SYSTEM

- Complete 12pc bin rack system for mounting to a wall or pegboard
- Comes with 6 mini bins, 6 small bins, 12.5 in. x 14.75 in. tall plastic mounting panel and hardware
- Bins will stack together for free standing storage or for transporting your parts to where they are needed



W530 *
Inner: 1 Master: 1



2-PC MAGNETIC TOOL HOLDER BAR

- Features strong double sided magnets so the bar will stick to most any steel surface
- Industrial looking carbon fiber textured finish will not scratch and can easily be relocated
- Length of the bar is flexible enough to contour onto a rounded surface
- 2 Tool bar holders are included that measure 11 x 2.5 x 7/16 in. thick



NON-SCRATCH SURFACE

W12526 *
Inner: 1 Master: 36

2-PC MAGNETIC PARTS TRAY SET

- Permanent magnet sticks to any ferrous metal surface
- Keeps small metal parts and tools from getting lost
- Sticks to any ferrous metal surface
- Rubber coating prevents scratches
- Sizes (diameter): 4" and 5-1/2"

W1280 *
Inner: 6 Master: 36



3/4 IN. MAGNETIC BASE

- Strongest available grade 8 ferrite ceramic magnet with threaded center hole and hook
- Use as a retriever, mounting hook, door holder or hanging tools, keys, hats and other lightweight items
- Detachable hook threads on and off easily for added versatility
- 8-pound pull rating (3.6 Kg)

W12527 *
Inner: 24 Master: 144



NEW



3-PC MAGNETIC TOOL ORGANIZER

- Set includes 8, 12, and 18 inch magnetic organizers
- Steel construction for dependable and long service life
- Easily mount to wall, work bench or any flat surface
- A powerful magnet to hold tools and other ferrous objects in place



W1286*
Inner: 6 Master: 12

3/8 IN. HEAVY DUTY REVERSIBLE DRILL

- Keyless 3/8 in chuck for fast and easy bit changes
- Convenient fingertip reverse for replacing screws or when binding occurs
- Long lasting multiple planetary gears with ball bearings
- 3/64 to 3/8-in. chuck capacity

M648*
Inner: 1 Master: 10



Specifications: Chuck Size: 3/8", Air pressure: 90 PSI, Average CFM: 4, Free speed: 1800 RPM, Air inlet: 1/4" NPT, Hose size: 3/8" ID

PRO GRIP
PROTECTIVE COATING

5-PC MAGNETIC TOOL SET

- Rubber coated permanent magnet prevents scratches and sticks to any ferrous metal surface, it even works upside down
- Heavy duty magnetic pickup tool extends to 24", lifts up to 5lbs and features a comfort grip and pocket clip
- Contents: Two 18" magnetic tool organizers, 5-3/8" x 9" magnetic parts tray, 6" round magnetic parts tray and magnetic pick up tool



W1281*
Inner: 1 Master: 6

HEAVY DUTY AIR HAMMER W/5 CHISELS

- Built-in regulator for precise speed control
- Single piece assembly for longer tool life
- Rubber coated housing for less fatigue and better handling
- Quick change coil spring retainer accepts standard .401 Parker Shanks
- Includes 5 chisels: flat, round, spot weld breaker, tapered punch, rivet cutter

M668*
Inner: 1 Master: 10



Specifications: Bore size: 3/4", Stroke length: 2.6", Free speed: 3500 BPM, Average CFM: 4.8, Air pressure: 90 PSI, Air inlet: 1/4" NPT, Hose size: 3/8" ID

3/8 IN. DR. AIR RATCHET

- Quality construction triple planetary gear design
- Lever throttle features variable speed for precise control
- Ball type retainer for positive socket retention
- Compact head for easy access in tight areas

M560DB*
Inner: 1 Master: 10

PRO GRIP
PROTECTIVE COATING



Specifications: 3/8" Dr., 10-50 Ft./Lbs Working Torque, Pressure: 90 PSI, Average CFM: 4, Free Speed: 150 RPM, Bolt capacity 15/16", Air Inlet 1/4", Hose size 3/8" ID



1/2 IN. X-TREME DUTY IMPACT WRENCH

- Commercial duty twin hammer clutch delivers an impressive 1010 ft pounds nut busting torque in reverse to loosen even the most stubborn bolts and 885 ft. pounds in forward for the most demanding jobs
- Variable speed and torque settings with two forward and one reverse
- Balanced motor design for low vibration, comfort during extended use
- Air Inlet: 1/4", Hose size: 3/8" ID, Rec. max bolt size 7/8".

M631*
Inner: 1 Master: 5



Specifications: 1/2" Drive, Max Torque: Reverse - 1010 Ft/Lbs, Forward: 885 Ft/Lbs, Working - 775 Ft/Lbs in 5 seconds, Free Speed: 9500 RPM, BPM: 1200, Air Pressure (PSI): 90, Avg CFM: 7

3-PC PRODUCTION SPRAY GUN SET

- Set includes: One production spray gun with a 1.3mm needle and nozzle set, a second production spray gun with a 1.5mm needle and nozzle set, and a third production spray gun with a 1.7mm needle and nozzle set for heavy solid material
- Fully adjustable spray pattern with control knob on side of guns

M707*
Inner: 1 Master: 5



Specifications: Nozzle sizes: 1.3mm, 1.5mm, 1.7mm, Cup capacities: 1000cc, Average CFM: 7-9, Air pressure: 15-45 PSI, Spray pattern of 3-7", Air inlet: 1/4" NPT, Hose size: 3/8" ID



2-PC PRODUCTION SPRAY GUN

- Set includes: One production spray gun with a 1.3mm needle and nozzle set for single stage materials, and a second production spray gun with a 1.5mm needle and nozzle set for heavy solid materials
- Locking pressure regulator with gauge

M706*
Inner: 1 Master: 5

Specifications: Nozzle size: 1.3, 1.5mm, Average CFM: 7-9, Air pressure: 15-45 PSI, Spray pattern of 3-7", Air inlet: 1/4" NPT, Hose size: 3/8" ID



50 FT. X 3/8 IN. HYBRID HOSE & REEL

- Retractable reel with fully enclosed case
- Automatic roller guide ensures smooth and even recoil
- Extremely flexible blend of rubber and PVC
- Bend restrictors at each end for long life
- 1/4" NPT brass male fittings
- Maximum working pressure: 300 PSI, Burst pressure: 900 PSI

M613*
Inner: 1 Master: 2



MAX 300 PSI
WORKING PRESSURE

3/8 IN. HYBRID AIR HOSES

- Extremely flexible blend of rubber and PVC
- Bend restrictors at each end for long life
- 1/4" NPT brass male fittings
- Working pressure: 300 PSI, Burst pressure: 900 PSI

M628* - 25 FT.
Inner: 1 Master: 10



M617* - 50 FT.
Inner: 1 Master: 3

MAX 300 PSI
WORKING PRESSURE

MACHINIST VISES

- 360 Degree swivel base
- Heavy duty cast iron construction
- Dual lock downs for easy positioning
- Replaceable hardened steel jaws
- Diamond serrated for a secure grip

DUCTILE IRON



MV4* - 4 IN.
Inner: 1 Master: 1

MV5* - 5 IN.
Inner: 1 Master: 1

MV6* - 6 IN.
Inner: 1 Master: 1

MV8* - 8 IN.
Inner: 1 Master: 1



3 IN. CLAMP ON VISE

- Portable design quickly clamps to any work surface up to 1-1/2 inch thick
- Durable powder coat finish and chrome plated hardware
- Twin steel guide bars and built-in pipe jaws
- 2-3/8 inch Jaw Opening, 1-5/8 inch Throat Depth



W3900*
Inner: 1 Master: 10

EXTRA WIDE FOLDING STEP STOOL

- Extra-wide 15-inch-wide platform for enhanced stability and safety
- Slip resistant rubber tread on platform and rubber foot pads for trouble free, non-skid performance
- Heavy-duty polystyrene is impact resistant and easy to clean for a long service life
- Compact design that easily folds up to save space and stores most anywhere

COLLAPSIBLE

W85041*
Inner: 1 Master: 8

NEW



300 lb.
LOAD CAPACITY

Sold in
MASTER QUANTITIES

5 IN. MULTI-PURPOSE VISE

- Durable ductile iron construction provides superior strength for a long service life
- Positive-locking 360 degree swivel base allows jaws to be used at any position
- Two sets of jaws, 5 in. standard for square stock and pipe jaws for round stock
- 2-1/2 in. x 3-1/8 in. flat anvil surface for forming, or reforming metal parts
- Double lock down screws for secure positioning
- Powder coated body to inhibit corrosion and resists scratches

MV11*
Inner: 1 Master: 1

DUCTILE IRON



NEW

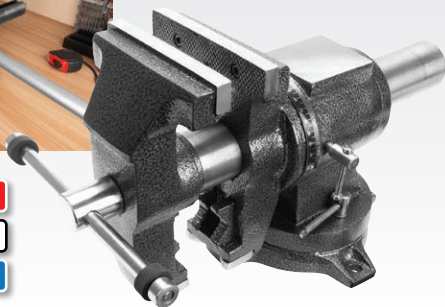

2 STEP FOLDING LADDER

300 lb.
LOAD CAPACITY

- Heavy duty polystyrene is impact resistant and easy to clean for a long service life
- Ladder stands upright when folded up using minimal storage space
- Slip-resistant tread on steps and rubber non-skid foot pads



COLLAPSIBLE

W85040*
Inner: 1 Master: 4

WRAP AROUND FACE SHIELD

- Durable head and face protection for use in metal fabrication, wood working, landscaping, utilities and many other industries
- Oversized shield allows user to wear most glasses and respirators even at the same time
- Constructed from clear polycarbonate material and meets CAN/CSA Z94.3 standards

W10030*
Inner: 1 Master: 20



NEW

FENDER COVER

- Heavy duty vinyl with foam backing
- Convenient built in tool pockets
- Fully sewn ribbed edge
- Size: 33" x 24"



PROTECT YOUR FENDER



W80583*
Inner: 1 Master: 12

MOVING BLANKETS

- Non-woven polyester outer shell with a cotton/polyester fill for padding
- Double stitched non-woven fabric ensures your blanket will be durable enough for big moves and storage
- All ends are finished to keep blanket from unweaving or fraying for long life

80 IN. x 72 IN.
W6045*
Inner: 1 Master: 4

40 IN. x 72 IN.
W6044*
Inner: 1 Master: 8



Limited to stock on hand.

60 IN. X 78 IN. CARGO NET

- Durable plastic hooks fit over 1 inch (25mm) bars and are easy to hook to a truck's anchor points
- Multi-strand rubber core center for extra strength
- Holds up under extreme weather conditions
- Bungee material stretches to fit odd shaped loads
- 60 Inch by 78 Inch. Only use for light loads, Black

ESSENTIAL FOR ALL TRUCKS

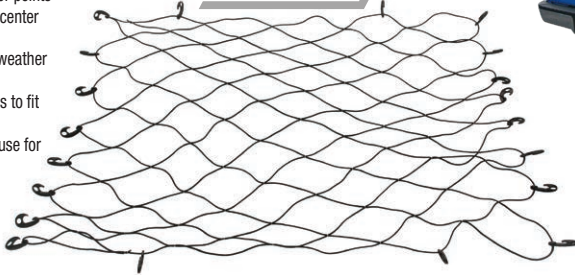

W1829*
Inner: 1 Master: 6

20-PC BUNGEE CORD ASSORTMENT

- Coated steel hooks with extra wide hook openings
- Multi-strand rubber core center for extra strength
- UV resistant color coded poly coating
- Storage jar included
- Assortment includes (2) 40-inch, (2) 30-inch, (4) 20-inch, (4) 15-inch, (6) mini and (2) canopy straps



W1890*
Inner: 1 Master: 9

RATCHETING CARGO BAR

- Adjustable cargo bar installs easily to prevent cargo from shifting in trucks, vans, and SUV's
- The ratcheting mechanism is used to add more tension for a tighter, stronger hold
- Cushioned rubber end pads to guard against slipping and scratches
- The steel bar adjusts from 40"-70"

ADJUSTS FROM 40 - 70 INCHES

W1447*
Inner: 5 Master: 10



TIE DOWN STRAPS

- 300 Lbs. load limit, 900 Lbs. break strength
- Ratcheting mechanism tightens with vise-like gripping power
- Vinyl coated steel hooks

W1824* - 2 PACK
Inner: 4 Master: 16

- 15-Foot long by 1-inch wide polyester webbing

W1870* - 4 PACK
Inner: 3 Master: 9

- 10-Foot long by 1-inch wide polyester webbing



300 LBS. LOAD LIMIT



6-PC TARP STRAP ASSORTMENT

- Weather resistant EPDM material will not rot or lose elasticity after continuous exposure to the elements
- Black rubber with plated steel S-hooks
- Includes (6) tarp straps, 2 each 15-inch, 21-inch, 31-inch black

W1891*
Inner: 1 Master: 9



4-PK 1 IN. X 15 FT. TIE DOWN STRAPS

- 15-Foot long by 1-inch wide polyester webbing
- 500 Lbs. load limit, 1500 Lbs. break strength
- Ratcheting mechanism tightens with vise-like gripping power
- Comfort-grip padded handles with vinyl coated steel hooks
- Webbing features olive drab camouflage pattern

W1840*
Inner: 3 Master: 6



500 LBS. LOAD LIMIT

2-PK 1 IN. X 6 FT. TIE DOWN STRAPS

- 6-Foot long by 1-inch wide polyester webbing
- Retractable mechanism eliminates mess and tangling
- Strap winds into handle with the simple push of a button
- 500 Lbs. load limit, 1500 Lbs. break strength
- Ratcheting mechanism tightens with vise-like gripping power
- Comfort-grip padded handles with vinyl coated steel hooks



QUICK RELEASE RETRACTABLE MECHANISM

500 LBS. LOAD LIMIT

W1861*
Inner: 3 Master: 9

2-PK TRUCK BED ANCHOR POINTS

- Fits most trucks, with or without bed liners including: Dodge Ram, Chevy Silverado, and GMC Sierra
- No drill installation
- Corrosion resistant chrome plated finish
- Rubber base provides a secure tight fit
- Fits securely in stake pocket, 2 pack, medium duty
- 500 Lb. load limit, 1500 Lb. break strength



Sold in INNER QUANTITIES

W1883*
Inner: 3 Master: 36



NEW



Sold in INNER QUANTITIES

2-PK ADHESIVE RUBBER SURE STEP

- Offers extra traction on trailer wheel wells, steps, ramps, or anywhere a non-skid surface is needed
- Strong adhesive backing adheres easily to any clean, smooth surface and prevents shifting or slipping
- UV and weather resistant rubber with diamond tread pattern
- 4 Inches Wide, 15-1/2 Inches Long (10 x 39.4cm)

W1893*
Inner: 6 Master: 18

4-PK FLIP RING ANCHORS

- 400 Lb. load limit, 1200 Lb. break strength
- Corrosion resistant zinc plated finish
- Easy to use design mounts to the floor or wall
- 4 hook and bracket sets, medium duty



Sold in INNER QUANTITIES



W1882*
Inner: 4 Master: 40

OUTDOOR ACCESSORIES

3/8 IN. X 100 FT. DIAMOND BRAID ROPE

- A great general purpose rope with many uses; from camping to landscaping or securing a load
- The braided polypropylene rope with non-woven cloth core is rot, mildew, abrasion, oil resistant and will even float on water
- Maximum weight capacity of 240 pounds (109kg)

W1899 *
Inner: 6 Master: 24



Sold in
INNER QUANTITIES

REBAR GROUND ANCHOR STAKES

- Sharp chisel point end helps to drive stake deep into the soil, even in rocky ground
- The rebar's ribbed exterior helps to hold stake firmly in place
- Durable painted black finish will inhibit rusting and make the stake less visible in its surroundings
- Welded on 1.25" steel loop provides a strong and secure anchor point

W9462 * - 18 IN.
Inner: 6 Master: 36

- Heavy duty 3/8" all steel construction will not bend under pressure

W9463 * - 30 IN.
Inner: 6 Master: 18

- Heavy duty 1/2" all steel construction will not bend under pressure

W9464 * - 48 IN.
Inner: 1 Master: 6

- Heavy duty 5/8" all steel construction will not bend under pressure

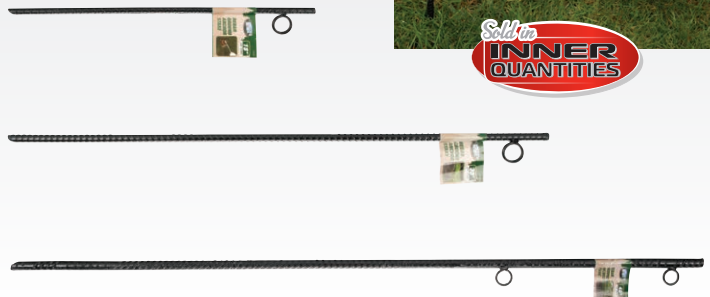

CAMPING ESSENTIAL



Sold in
INNER QUANTITIES

FLYWEIGHT POCKET KNIFE

- Ultra-lightweight, low profile design weighs only 1.7 ounces (48g)
- Finger flipper and thumb stud provide quick and easy opening
- Black, 3CR13 stainless steel drop point blade with inline blade lock
- Skeleton frame with comfortable hardwood handle and pocket clip
- 3 inch (8.0 cm) stainless steel straight edge blade; 7-1/4 inch (18.4 cm) overall open length

ULTRA LIGHTWEIGHT

NEW



W9378 *
Inner: 12 Master: 96

LI-ION LED RESCUE KNIFE

- Features LED light, glass breaker and carabiner clip
- 3" straight edge stainless steel Tanto blade
- Lithium ion rechargeable battery
- 7.9" overall length, 4.8" closed length
- Includes micro USB recharging cable

LED



W9362 *
Inner: 1 Master: 8

RESCUE KNIFE

- 3 1/2" stainless steel blade, 8 1/2" overall open length
- Dual thumb studs for easy opening, Liner lock, Belt clip, Partially serrated blade, Tempered glass breaker, & Seat belt cutter

EMERGENCY ESSENTIAL



W9341 *
Inner: 6 Master: 48



SANGA CARBON FIBER POCKET KNIFE

- Stainless steel roller bearing pivot point provide smooth and easy opening
- High strength, lightweight and ergonomic carbon fiber handle
- 3-1/4 inch (8.3cm) stainless steel blade, 7-3/4 inch (19.7cm) overall open length
- Finger flipper and thumb stud for easy one hand operation

W9363 *
Inner: 6 Master: 48



SEETA WOOD HANDLE POCKET KNIFE

- Assisted opening mechanism for quick and easy operation
- 3-1/4 inch stainless steel straight edge drop point blade, 8 inch overall open length
- Thumb studs on both sides of blade
- Inline blade lock/release mechanism
- Pocket clip

W9366 *
Inner: 6 Master: 36

While Supplies Last



2-PK WOOD HANDLE POCKET KNIVES

- Beautiful hardwood handles provide comfort and durability
- Blade cutout for easy opening in either hand
- Inline blade lock/release mechanism
- 1-1/2 inch stainless steel clip point blades, 4-5/8 inch overall open length, 2-1/2 inch folded length
- Pocket clip

W9370 *
Inner: 6 Master: 48

While Supplies Last



2-PC TACTICAL KNIFE SET

- Anodized aluminum skeleton frames are light weight and long lasting
- Utility knife features quick change blade, and push button lock to prevent accidental opening or closing
- Liner lock on pocketknife for safe and easy operation
- Each knife features an integrated carabiner pocket clip with spring-loaded catch

W9376 *
Inner: 6 Master: 36



4-IN-1 KNIFE SHARPENER

- Essential tool designed to sharpen a variety of tools including pocket knives, scissors, machetes, kitchen knives, multi-function tools, blades and more*
- Features 4 slots: Slot 1 features a notched tungsten steel blade to sharpen scissors. Slots 2, 3 and 4 offer 3-stage knife sharpening for restoring your blade to a precision edge
- Non-Slip rubber base creates a firm foundation for a steady grip and smooth, stable sharpening

NEW

W9405 *
Inner: 8 Master: 32

VARIETY OF SHARPENING OPTIONS



BLACK CABLE TIES

NEW

- Self-locking cable ties grip securely and provide a quick, inexpensive way to secure wires, hoses, fencing and more
- Nylon 6/6 resins are UL/CE tested for purity, made using ISO 9001 manufacturing and our 100% QC inspections guarantee outstanding performance and consistency
- UV stable black nylon, CE lab certified, is approved for use in continuous exposure to outdoor sunlight

500-PIECE 8 IN.

- Tensile strength: 50lbs

W2940 *
Inner: 6 Master: 24

100-PC 4 IN.

- Tensile Strength 18 Lbs

W2904 *
Inner: 10 Master: 100

100-PC 8 IN.

- Tensile Strength 40 Lbs

W2910 *
Inner: 10 Master: 100

50-PC 18 IN.

- Tensile Strength 120 Lbs

W2924 *
Inner: 1 Master: 100

100-PC 12 IN.

- Tensile Strength 50 Lbs

W2912 *
Inner: 10 Master: 100

100-PC 14 IN.

- Tensile Strength 50 Lbs

W2915 *
Inner: 10 Master: 100

100-PIECE 15 IN.

- Tensile Strength: 120lbs (55kg)

W2941 *
Inner: 10 Master: 30



1,000-PC CABLE TIE ASSORTMENT

- Four lengths, color coded
- 500 4", 100 6", 300 8" and 100 12" cable ties
- Great for home, shop, office, RV, boat and so much more

W2925 *
Inner: 6 Master: 12

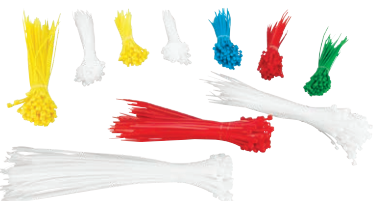

250-PC NYLON CABLE TIE ASSORTMENT

- Nylon 6/6 resins are UL/CE tested for purity, made using ISO 9001 manufacturing and our 100% QC inspections
- UV stable carbon added to the nylon material of our white and black cable ties provide longer lifespan in sunlight
- Assortment: 100pc - 4", 18lb cable ties in black and white / 50pc - 8", 40lb cable ties in white

W2942 *
Inner: 10 Master: 100

NEW



250-PC CABLE TIE ASSORTMENT

- Handy assortment for the home, office, or shop
- Clear plastic tubes keep small pieces in one place, easy to find
- 4 inch: Yellow, blue, 25pcs each; 18lb tensile strength
- 6 inch: White, black, 25pcs each; 18lb tensile strength
- 8 inch: Red, green, 25pcs each; white, black, 50pcs each; 40lb tensile strength

W2918 *
Inner: 1 Master: 12



25-PIECE 8 IN. ID MARKER CABLE TIES

- These ID marker cable ties have a 1 x 0.6" label area which allows you to mark wires or bundles for identification while securing them together at the same time
- Nylon 6/6 resins are UL/CE tested for purity, made using ISO 9001 manufacturing standards and our 100% QC inspections guarantee outstanding performance and consistency
- UV stable black nylon, CE lab certified, is approved for use in continuous exposure to outdoor sunlight

W2945 *
Inner: 10 Master: 100



NEW



WHITE CABLE TIES

- Self-locking cable ties grip securely and provide a quick, inexpensive way to secure wires, hoses, fencing and more
- Nylon 6/6 resins are UL/CE tested for purity, made using ISO 9001 manufacturing and our 100% QC inspections guarantee outstanding performance and consistency
- UV stable white nylon, CE lab certified, is approved for use in continuous exposure to outdoor sunlight

100-PC 8 IN.

- Tensile Strength 40 Lbs

W2908 *
Inner: 10 Master: 100

100-PC 12 IN.

- Tensile Strength 50 Lbs

W2913 *
Inner: 10 Master: 100

100-PC 14 IN.

- Tensile Strength 50 Lbs

W2917 *
Inner: 10 Master: 100

50-PC 18 IN.

- Tensile Strength 120 Lbs

W2926 *
Inner: 10 Master: 100



10-PIECE 14 IN. STEEL CABLE TIES

- Ties are made of 304 grade stainless steel which is high strength, nonflammable and offers excellent corrosion resistance for an uncompromising wear resistance
- Advanced roller ball self-locking design for superior holding strength and secure installations
- Low profile design and fully rounded edges with smooth surfaces to protect cables from long term damage

W2946 *
Inner: 20 Master: 200
• Tensile strength: 220lbs (100kg)

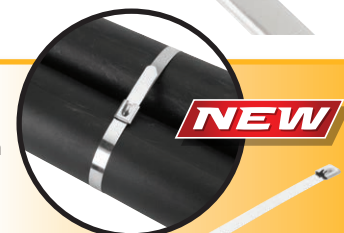

NEW

W2947 *
Inner: 20 Master: 160
• Tensile strength: 396lbs (180kg)

300-PC NYLON CABLE TIE ASSORTMENT

- Nylon 6/6 resins are UL/CE tested for purity, made using ISO 9001 manufacturing and our 100% QC inspections guarantee outstanding consistency, performance, and durability
- UV stable carbon added to the nylon material of our white and black cable ties provide longer lifespan in sunlight compared to most other brands

W2943 *
Inner: 10 Master: 100



50-PIECE CABLE TIE MOUNTS

- Self-adhesive 1" square mounts allow you to attach cable ties directly to flat solid surfaces
- Adhesive backing works well for light duty applications but when extra holding capacity is needed use the 2 built-in holes to screw or rivet mount to surface
- Mounts have 4-way cable tie entry points and allows for horizontal or vertical securing

NEW



W2944 *
Inner: 10 Master: 100

ADJUSTABLE CABLE TIE GUN

- High impact nylon and fiberglass body
- Adjustable bundling pressure
- Flush cuts end of cable tie
- Capacity: 3/32" (2.4mm) to 3/16" (4.8mm) wide, up to 1/16" thick

W2919 *
Inner: 6 Master: 48



CLEANING

BLACK NITRILE GLOVES

- Provides a protective barrier against dirt, grime, oil, chemicals and solvents
- Textured fingertips for better grip
- Comfortable fit and feel
- Powder/latex free
- 100 Gloves per box

W89011* - MEDIUM
Inner: 1 Master: 10

W89012* - LARGE
Inner: 1 Master: 10

W89013* - X-LARGE
Inner: 1 Master: 10



3 PAIR LEATHER WORK GLOVES

- Reinforced palms and knuckles offer additional protection and comfort
- Durable yet soft split leather is flexible and comfortable for use in a variety of work environments
- Cotton lined backing allows for improved airflow and breathability
- Thick fabric on the fingers and palm provide added protection and excellent grip

W89020*
Inner: 1 Master: 24



While Supplies Last

JERSEY COTTON KNIT GLOVES

- All-purpose gloves made of a cotton polyester blend that is lightweight but durable and can also be worn as liners for outer gloves
- Reusable jersey material is lightweight, breathable, comfortable and easy to clean
- Approximately 10" long (250mm) with stretchable cuff, and flexible material to fit most adult size hands



W89024*
Inner: 12 Master: 300



2-PC BRASS DETAILING BRUSH SET

- Features contoured offset handles for better access, and sure-grip grooved PVC handles
- The brass bristles make these non-sparking, non-magnetic, and corrosion resistant wire brushes
- Each detail brush is 1/2 in. wide, the small has 1 in. bristles and the medium has 3 in. bristles
- Set includes a small 6-1/2 in. long and a medium 8-5/8 in. long brush

W4951*
Inner: 12 Master: 72

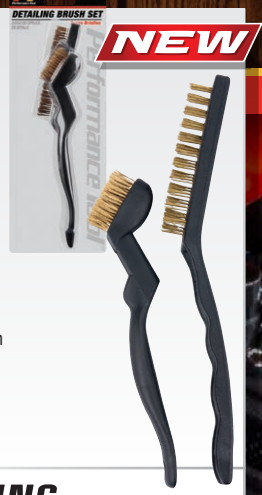

6-PC DETAILING BRUSH SET

- Features contoured offset handles for better access, and sure-grip grooved PVC handles
- Nylon bristles for tile and grout, brass coated for dirt, and paint and steel bristles for everything else
- Includes six different brushes, three small 6-1/2 in. long and six medium 8-5/8 in. long
- Each detail brush is 1/2 in. wide, the small has 1 in. bristles and the medium has 3 in. bristles

W4950*
Inner: 6 Master: 36



17 IN. ALUMINUM DUSTPAN

- Extra-large 17" aluminum metal dustpan for the heaviest of clean ups
- Lightweight, corrosion resistant aluminum is half the weight of steel ones
- Wide design with low profile leading edge is great for large clean-up jobs
- Double riveted, looped tubular steel handle provides strength and rigidity, and easy storage
- Dimensions: 16-1/2 in. (42cm) wide at mouth, 9 in. (23cm) depth, 2 in. (5cm) high at the back

W30*
Inner: 1 Master: 24

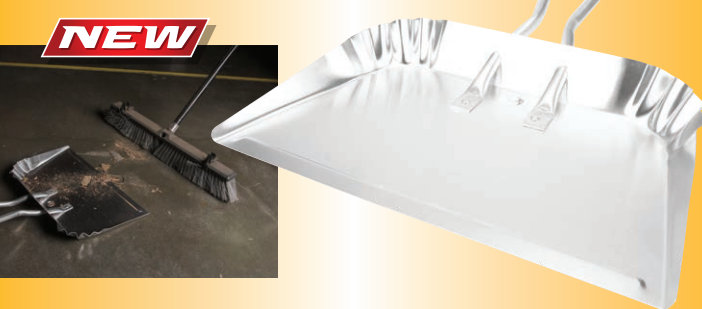

MECHANIC'S HAND BAR SOAP

- Infused with rice and charcoal to provide a better clean
- Lightly abrasive to remove even the toughest grease and grime
- Designed for those heavy duty jobs that cover your hands in grease, soot, tar, paint, dirt, grime, oils, adhesives and more
- Ingredients: sodium palmate, sodium palm kernelate, oryza sativa powder, (rice + bamboo charcoal), glycerin, fragrance, Decyl Glucoside (APG), water

20235*
Inner: 8 Master: 128



ESSENTIAL FOR MECHANICS

40-PK INDUSTRIAL MECHANIC WIPES

- The heaviest duty wipes you will ever find! Water saving, moisturizing, eco-friendly and a fresh lemon scent
- Powerful ingredients combine three different oils that clean the toughest of dirt, grease, grime, oil, paint, tar, sludge, silicone, adhesives and more
- Unlike mostly water-based wipes that only clean water-based materials, PT wipes feature lemon oil, olive oil, and mineral oil to remove everything the other wipes leave behind
- Certified non-toxic, non-Prop 65 ingredients are safe, anti-bacterial, gentle on your hands, and still clean thoroughly



W1479*
Inner: 1 Master: 16



225-PC COTTON CLEANING SWABS

- Industrial strength, low lint cotton swabs with excellent solvent holding capacity are ideal for cleaning or lubricating engine parts, fittings, guns or any hard to reach area
- Strong, flexible bamboo handles will bend without breaking to help keep your hands clean and apply extra cleaning pressure as needed
- Sizes included: (100) - 5mm x 7.6cm, (50) - 5mm x 15cm, (25) - 12mm x 19.5cm, (25) - 16mm x 21cm and (25) - 20mm x 21.5cm

W1470*
Inner: 6 Master: 48



3-IN-1 TELESCOPING SNOW BRUSH

- Double ended tool with 10" brush/squeegee head, and 5-7/8" ice scraper
- Strong, lightweight aluminum twist lock telescoping handle for extended reach
- Durable ABS and polypropylene construction
- Soft foam grips for comfort and control



W1465*
Inner: 1 Master: 12

32.5-43.5" Overall

TELESCOPING DESIGN

24 IN. SNOW BRUSH/ICE SCRAPER

- Convenient design puts both tools on the same end for easy operation
- Ergonomic rubber handle provides positive grip in wet conditions
- Durable ABS and polypropylene construction holds up in the coldest of winters
- Scraper features built-in teeth for breaking up compacted ice
- Brush for removing snow and smaller bits of loose ice left over after scraping



W1461*
Inner: 12 Master: 24

24" Overall

ERGONOMIC DESIGN

2-IN-1 WINDOW CLEANER/SCRAPER

- Fast and easy tool for cleaning the inside windows of your home or vehicle
- Telescoping handle extends from 14.75 to 19 inches (37.5-48.5cm)
- 180° triangular swivel head allows you to clean hard to reach corners and back or side windows
- Soft microfiber cover is safe to use on all surfaces and will not scratch interior or exterior surfaces of your car, truck, SUV or and recreational vehicle



W1462*
Inner: 6 Master: 24

White Supplies Last

TELESCOPING DESIGN

ICE SCRAPER

- Heavy-duty scraping blade with ice ripping teeth
- Sturdy construction holds up in extreme weather
- Flat, compact design stores easily
- 9 1/2" long with 4 1/4" wide blade



W9197*
Inner: 12 Master: 48

ICE SCRAPER/ SQUEEGEE MERCH STRIP - W465*

- 3 in 1 tool for ice breaking, scraping and wiping
- Low profile design stores anywhere
- High impact ABS construction



W9166* - MERCHANDISER
Inner: 24 Master: 96

ANTIFREEZE TESTER

- Color coded balls for easy readings

W1655C*
Inner: 24 Master: 288



DELUXE ANTIFREEZE TESTER

- Easy to read scale & pointer
- Freezing to boiling points for anti-freeze, calibrated in °C and °F



W1656C*
Inner: 6 Master: 72

16-PC POWER BRUSH DETAILING KIT

- A comprehensive assortment of brushes, pads and towels to make detailing your auto, boat or home easier, faster, and more practical
- Includes: (3) Drill brushes: 2, 4, and 3-1/2" domed, (2) 4" Polishing pads, 4" Backer pad, (2) 400G Towels, 100g Wash mitt, (5) Detail brushes: 3/4 - 1-1/4", Vent brush, clear plastic storage tote

NEW



W4992*
Inner: 1 Master: 4



READING GLASSES

- Comfortable, light weight reading glasses that combine visual clarity and outstanding durability
- Lightweight frame material flexes instead of bending to provide serious shock-absorbing durability, fit and comfort
- Rectangular acrylic lenses have a hard protective clear coating to protect them against impact and scratching
- Measurements: Temple width - 5.9 in. (150mm), Lens width - 2.13 in. (54mm), Bridge width - 0.67 in. (17mm), Weight: 0.8 oz. (20g)



NEW



+1.5 STRENGTH
W1490*
Inner: 10 Master: 240

+2.0 STRENGTH
W1491*
Inner: 10 Master: 240

+2.5 STRENGTH
W1492*
Inner: 10 Master: 240

Sold in **INNER QUANTITIES**

1000LM LI-ION SQUARE WORK LIGHT

- Professional Grade Licensed COB [Chip-On-Board] Strip
- Strong Magnet on the back and hook
- Water resistant rated IP44
- Powered by built-in (2) 3.7V 1500mAh 18650 Lithium-Ion rechargeable battery (included)
- Micro USB charging cable included

1000 LUMENS

DOUBLES AS POWER BANK

NEW



5 Output Settings: COB High beam 1000 lumens, COB Medium beam 500 lumens, COB Low beam 120 lumens, Top LED High beam 200 lumens, Top LED Low beam 65 lumens

189*
Inner: 6 Master: 24



NEOPRENE PROTECTIVE WORK MAT

- Oversized mat provides a protected work space
- Neoprene construction is chemical resistant to protect your work surface
- Top thermo-fiber layer provides you with a firm but cushioned work surface while the 3mm thick rubber backing
- Ruler with standard / metric measurements and several reference charts including SAE/Metric, fluid, and oil to gas ratios

Sold in **INNER QUANTITIES**



DIMENSIONS:
16 X 35.75 INCHES

PROTECT YOUR WORKSPACE

W88977*
Inner: 12 Master: 24

DUAL FLAME TORCH

- Adjustable and windproof dual flame
- Made of high-quality brass and stainless steel
- Clear window showing fuel level - 1.6g
- Includes cigar punch
- Butane refillable - Butane not included

NEW



802*
Inner: 12 Master: 72

BUILT-IN CIGAR PUNCH



WINDPROOF



REFILLABLE



DOUBLE JET FLAME



Wilmar, LLC

P.O. Box 88259 Tukwila, WA 98138

e-mail: tools@wilmarllc.com
1-800-426-1262 USA & Canada
1-800-352-9185 Fax

***⚠WARNING: Cancer and Reproductive Harm -www.P65Warnings.ca.gov**



WS-2022-10

© Copyright 2022 Wilmar, LLC. This material is being furnished for the exclusive use of Wilmar customers and may only be used in connection with the sale of Wilmar®, Performance Tool®, Performance Tool®, airTIGHT™, Northwest Trail®, Project Pro®, Mechanics Products® and ATAK® brand merchandise. Any other use is strictly prohibited. Illustrations and photographs are intended for reference only. Actual products may vary. On occasion, after printing of our catalogs, flyers or other sales aids is completed, the manufacturers may make changes and/or modifications to merchandise which will not be reflected in this literature. Accordingly, when ordering, please inquire of our sales representative as to any such changes or modifications which have been made following publication. Wilmar is not responsible for typographical, grammatical, numerical or hyphenation errors.