

QUALITY | INNOVATION | SATISFACTION



HAND TOOLS | ELECTRICAL | TIRE REPAIR | LIGHTING | SHOP & GARAGE



FALL & WINTER SPECIAL 2024!

OIL CHANGE | DEMOLITION | LUBRICATION | BATTERY SERVICE | LIFT EQUIPMENT



Wilmar, LLC

PT POWER

**Northwest
Trail**

ATAK®

FEATURED ITEMS

HEAVY DUTY SHOP TABLE

W54991*
Inner: 1 Master: 1

NEW

- 60 in. (152.4 cm) heavy duty all steel work bench.
- Adjustable feet for leveling on uneven surfaces.
- Ultra durable powder-coated finished.
- Full length bottom shelf.
- Heavy gauge steel construction with high grade fasteners.
- 1400 lb. (635 kg) weight capacity.
- Raised lip on three sides of the top to prevent parts and liquids from rolling away



ROLLED EDGE FOR STRENGTH



PNEUMATIC STOOL W/ REMOVABLE BACKREST

- Removable backrest allows use as two different seats in one - use as an adjustable height chair, or remove for use as a stool
- Pneumatic action adjusts seat height quickly and easily
- 13-1/2 in. (34.3cm) diameter synthetic leather foam padded seat with 360° swivel
- Heavy duty steel tubing frame with matte black powder coated finish
- Wide footstool base provides a stable foundation and footrest
- 330 lb. weight capacity (150kg)

W85016*
Inner: 1 Master: 1



REMOVABLE BACKREST

PERFECT FOR SHOP OR GARAGE



48 X 30" ANTI-FATIGUE FLOOR MAT

- Non-slip neoprene rubber backing holds mat firmly in place for safety and is low profile enough for use as an inside threshold doormat
- 1/4 in. thick mat dramatically reduces pressure on your feet, knees, lower back and insulates your feet from a cold or slick floor
- Top thermo-fiber layer looks great and cleans off easily
- Nominal Measurements: 30 x 48 x 1/4 in. thick

Sold in MASTER QTY.

W7702*
Inner: 1 Master: 4

REDUCES PRESSURE ON FEET, KNEES, & LOWER BACK



FOLDING TOOL CART

- Three shelf collapsible rolling cart features tough polypropylene trays, durable aluminum posts, and 3 in. (75 mm) swivel casters.
- Innovative design quickly and easily folds up for compact portability and storage in spaces less than 8 inches in depth.
- Rubber over-molded handle provides a comfortable, positive grip for maneuvering your workload.
- No assembly required, converts from operable position to storage position in seconds.
- Each shelf measures 23 x 14.3 x 1 in. deep (58 x 36 x 2.5 cm), with the bottom two shelves featuring 12 in. (30 cm) of clearance. Folded size: 7.5 x 16 x 42 in. (19 x 40 x 107 cm).

NEW

200 lb. LOAD CAPACITY



FOLDS IN SECONDS

W53990*
Inner: 1 Master: 1

8-IN-1 MULTI-TAP OUTLET

- 8-in-1 power strip features 4 grounded 120-volt outlets 3 standard USB ports and 1 USB-C port
- Built-in smart chip automatically senses your connected devices
- USB-C port delivers up to 5V/3A max (15W), and 30% faster charging
- High quality construction features fire-retardant casing up to 1382° F (750° C)
- Maximum current/voltage: 1250W/10A @ 120V; USB-A: 12W/2.4A @ 5V; USB-C: 15W/3A, @ 5V
- cETL listed 5003828

W2266*
Inner: 10 Master: 30



LI-ION CORDLESS HEAT GUN

- The most compact rechargeable cordless heat gun on the market
- Heats up to a maximum temperature of 600 degrees Fahrenheit (315C) within 10 seconds
- The built in 3.6V, 2.0Ah Lithium-Ion battery has a working time of 15-20 minutes
- Recharge battery in under 2 hours using the included USB compatible power cord

W2082*
Inner: 6 Master: 24



26" POWER TOOL STORAGE RACK

- The 3 levels of storage easily fit 7 power tools, chargers, batteries, and accessories helping to keep everything together and easy to grab when needed.
- The heavy 9-gauge steel frame, fully welded shelves, and 5 mm thick wire will support up to 100-pounds of total storage.
- 34 holes along the back of the top shelf can be used to store screwdrivers or other accessories.
- The 2 sets of mounting holes are 25.875 in. (67.3 cm) apart and will work well for mounting to standard peg board hole spacing.

100 lb.
LOAD CAPACITY

NEW



W7703*
Inner: 1 Master: 4

20V BRUSHLESS 1/2" LI-ION IMPACT WRENCH

- Powerful 20V brushless motor delivers up to 295 ft. lb. (400 Nm) of forward and 375 ft. lb. (508 Nm) of nut busting reverse torque.
- Advanced electronic motor control provides 4-speed/torque settings.
- Optional Auto-Break mode works in reverse to deliver full breakaway torque, then stops rotation as soon as the lug nut or bolt breaks loose, preventing bolt stripping and uneven loosening.
- 100-Lumen LED work light built-in for increased visibility.
- 20V 2.0 Ah Lithium-Ion battery, with power level indicator, and 1-hour quick charger, gets you back up and running quickly.
- Blow mold storage case fits the entire kit and has room for an extra battery, if needed.
- CE, cETLus listed - 3159543

NEW

LED LIGHT & 4 SPEED
IMPACT SETTINGS



W7720*
Inner: 1 Master: 5

Specifications: Drive: 1/2 in. Square friction ring. Motor: 20V 4815 Brushless.
4-Speed/Impact settings: 0-1200/1600, 1600/2100, 2000/2700, 2400/3200 RPM/IPM.
Measurements: 6.0 L x 7.35 H x 2.45 in. D (15.2 x 18.7 x 6.2 cm), Weight: 2.5 lb. (1.3 kg).

8 PC. MAGNETIC NUT DRIVER BIT SETS

- Powerful magnets hold fasteners in place providing one handed operation.
- Rounded socket corners prevent stripping of fasteners by applying torque to the sides of the fastener.
- 1/4 in. quick release hex shank, 6 in. total length (150 mm) and an insert depth of 1/8 in.
- Heat treated impact grade chrome vanadium steel
- Black phosphate coating provides maximum strength and corrosion resistance.

NEW

COMES WITH
HOLDERS



METRIC W9065*
Inner: 6 Master: 24
7, 8, 9, 10, 11, 12, 13, and 14 mm

SAE W9064*
Inner: 6 Master: 24
1/4, 5/16, 11/32, 3/8, 7/16, 15/32, 1/2, and 9/16 in.

IMPACT
GRADE

1500-WATT INFRARED SHOP HEATER

- Infrared technology heats up the person or object rather than the air
- Energy efficient operation converts nearly all energy into heat
- Carbon fiber glass enclosed tube heats up quickly and evenly
- Moisture resistant for operation in or covered outdoors (do not expose directly to rain or water)
- Adjustable thermostat levels for optimum indoor and outdoor comfort and automatic overheating shut-off
- 8-ft grounded cord
- cETL listed 4006887



W5008*
Inner: 1 Master: 1

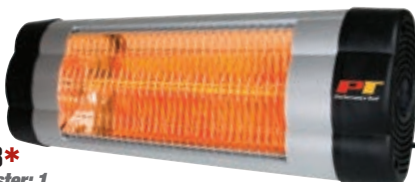

250-WATT PERSONAL SPACE HEATER

- Compact and light weight enough for used on top of your desk to keep your hands warm or underneath for your cold feet and legs
- Efficient ceramic coils heat up in seconds while the quiet direct drive fan delivers 853 BTUs of warmth
- Safety is built-in with tip-over and overheating protection that automatically shuts off the heater if knocked over or the heating elements overheat
- The sturdy 6' power cord has plenty of reach to direct heat where needed without the use of an extension cord

W5011*
Inner: 1 Master: 6



COMPACT
DESIGN

3 PC. 2-IN-1 SOCKET ADAPTER SET

- Dual-purpose extension nut drivers fit 1/4, 3/8, and 1/2 in. square drive sockets.
- The 2 larger drivers have 1/4 and 5/16 in. magnetic hex nut drivers built-into the ends.
- Retaining ring collar ensures sockets are securely attached.
- Impact grade chrome vanadium steel with rust resistant black phosphate finish.
- 2-1/2 in. long (65 mm)

NEW



2-IN-1
DESIGN

W2962*
Inner: 25 Master: 100

1/4" HEX IMPACT ADAPTERS

- Convert your 3/8" or 1/2" square drive impact tool into a powerful 1/4" hex bit driver
- Positive locking quick change collar delivers wiggle free bit retention and solid on center rotation.
- Constructed of chrome molybdenum steel for heavy-duty impact applications and long service life.



IMPACT
GRADE

3/8" DR.
W9039*
Inner: 12 Master: 72



1/2" DR.
W9028*
Inner: 12 Master: 72



1500-WATT CERAMIC SPACE HEATER

- With 3 settings, high-1500w, low-750w, and fan only, the heater puts out up to 5120 BTUs
- The heavy duty stainless steel heating coils with ceramic baffles delivers immediate and consistent heat
- The stay-cool housing is safe to touch even after hours of use at the highest heat setting
- The 120 volt, 12.5 amp heating element has built-in safeguards including an overheat protection sensor
- Standard 6 ft. 3 prong power cord allows greater range of mobility
- cETL listed #70-0546



W5010*
Inner: 1 Master: 4

FEATURED ITEMS

104 SLOT BATTERY ORGANIZER

- Keep all your batteries organized and neatly stored while preventing corrosion and depletion from improper storage
- Features removable battery tester that doesn't require a battery (slide left to remove from organizer)



WJ3001*

Inner: 1 Master: 12

Holds up to 104 different size batteries; (45) AA, (36) AAA, (4) 9 volt, (8) C, (6) D and (5) CR2016, CR2025, or CR2032 button cells (Batteries not included)

12V PORTABLE VACUUM CLEANER

- High-powered suction in a compact, portable, and lightweight unit. Replaceable and washable HEPA filter captures smaller particles
- Operates directly from a 12V outlet in your vehicle
- Includes 5 attachments: crevice tool, bristled brush, dust brush, 11 in. hose, 10 in. extension



WJ50012*

Inner: 4 Master: 16

12V HEATED TRAVEL BLANKET

- 3 heat settings, Low / Medium / High, lets you adjust the temperature to just the right amount of heat; up to 149°F (65°C) max
- Built-in automatic 45 minute timer prevents overheating and will not unintentionally drain your battery leaving you stranded
- At approximately 43" x 59" and made out of plush polar fleece
- The extra long 94" power cord plugs into any DC accessory / cigarette lighter power outlet
- Specifications: Input: 12v DC, Max current: 4.5A, Rated power: 50-Watt, In line fuse: 8 Amp, Power cord: 94". Safety: Built in overload shut off



Sold in MASTER QTY.

WJ6049*

Inner: 1 Master: 6

12V 2-IN-1 HEATER/DEFROSTER

- Use this compact 12 volt heater to quickly defrost / warm windshields and surfaces
- 360 degree swivel base for dash mounting
- Swing-out handle lets you use the heater as a spot defroster
- Three position heat switch
- 15 amp in-line blade fuse



WJ5009*

Inner: 1 Master: 12

1/2" DR. IMPACT WRENCH, 12V DC



- 1/2" drive impact wrench plugs into your vehicle's 12 volt DC outlet (cigarette lighter port) and delivers up to 250 ft. pounds of torque to remove lug nuts
- 12 ft. power cord easily reaches all four wheels and has an in line fuse to protect your tool and vehicle
- Comes with 4 impact grade, Chrome Vanadium, sockets to fit most common lug nut sizes - 11/16 in / 17 mm, 3/4 in / 19 mm, 13/16 in / 21 mm., 7/8 in. (23 mm.)

BLOW MOLD CASE INCLUDED

WJ50099*

Inner: 1 Master: 6

MAGNETIC CUP HOLDER

- Integrated ceramic magnets are covered by a scratch preventing rubber coating but are still powerful enough to hold up to 8 pounds.
- Made of durable impact resistant plastic.
- Cup holder measures 3-5/8" diameter, 3-5/8" high in the front and 4-5/8" tall in the back

WJ12525*

Inner: 1 Master: 50



REFLECTIVE SAFETY VEST

- ANSI/ISEA 107-2020 Class 2 and CSA Z96-15 Class 2, Type-R standards.
- Sewn 2 in. (50 mm) wide highly reflective silver strips, 2 over the shoulders and 2 around the waist.
- 2 large chest pockets.
- L/XL measurements: Neck - 8-5/8 in. (22 mm); Shoulder - 19-5/8 in. (50 mm); Chest - 26-3/4 in. (68 mm); Length - 26 in. (66 mm)

NEW

WJ1580*

Inner: 1 Master: 100



16 PC. POWER BRUSH CAR WASH DETAILING KIT

- A comprehensive assortment of brushes, pads and towels to make detailing your auto, boat or home easier, faster, and more practical
- Includes: (3) drill brushes: 2, 4, and 3-1/2" domed, (2) 4" polishing pads, 4" backer pad, (2) 400g towels, 100g wash mitt, (5) detail brushes: 3/4 - 1-1/4", vent brush, clear plastic storage tote



WJ4992*

Inner: 1 Master: 4



NEW

EMERGENCY FIRE BLANKET

- 40 in. x 40 in. (1 m x 1 m) Emergency fire blanket.
- Designed to throw over small fires to extinguish them before they become out of control.
- Rated to extinguish class A, B, and C fires.
- Simple to use and less mess than traditional fire extinguishers

WJ905*

Inner: 1 Master: 35



13,000 LB. GVW VEHICLE RAMPS

- 13,000 lb. (5909 kg) total gross vehicle weight capacity allows safe performance of repair and maintenance underneath your vehicle.
- Concave wheel rest surface and raised stop end provide added strength and stability.
- Molded traction treads and gentle 17-degree incline provide easy loading even for low clearance vehicles.
- Heavy duty polypropylene construction with slip-resistant rubber feet to resist sliding while loading.

NEW

3250 lb.
CAPACITY
Per Ramp*



W41013*

Inner: 1 Master: 1

Specifications: maximum 3,250 lb. (1477 kg) per ramp, 6,500 lb. (2955 kg) per pair working load capacity, dimensions: 35-5/8 x 12-1/8 x 8-1/4 in. (90.5 x 30.8 x 21 cm); 6-1/4 in. (15.9 cm) maximum lift height.

1 TON CAPACITY FOLDABLE SHOP CRANE

- The crane is equipped with a long ram jack, chain, and clevis hook assembly.
- Four 3-1/2 in. (89 mm) double-bearing swivel casters (two locking), and two 3 in. (76.2 mm) swivel casters.
- The long ram jack is equipped with a load-limiting safety valve preventing over lifting.
- Crane height adjusts from 75 in. to 84-3/8 in. (190.5 cm to 214 cm).
- Boom extends from 35-1/4 in. to 45-7/8 in. (89.34 cm to 116.5 cm).
- Base length 63 in. (160 cm) Base width 35 in. (89 cm).
- Engineered to comply with ASME-PASE 2019 industry standards

NEW

ADJUSTABLE HEIGHT

COLLAPSIBLE DESIGN



W41049*

Inner: 1 Master: 1

2-IN-1 40" Z-FRAME FOLDING CREEPER

- Easily converts from a creeper to rolling seat for all your automotive and shop needs.
- Fully padded cushions create a comfortable surface for laying flat or sitting upright.
- Six shielded 2 in. (50 mm) swivel casters allow for easy 360° movement and added stability.
- Creeper mode offers a low profile design that provides improved clearance.
- Use replacement caster assembly Performance Tool model W85002

NEW

TRANSFORMS IN SECONDS



W85018*

Inner: 1 Master: 1

300 lb.
LOAD CAPACITY

2-IN-1 ADJUSTABLE MOBILE TOOL TABLE

- Two-in-one rolling service table, with removable mobile tool tray.
- Use with our W85038 High-Top Creeper to eliminate climbing up and down looking for the right tool.
- The worktop can be removed and used under the vehicle as a rolling part and tool tray.
- The tool tray has several divided compartments including two that are magnetic for fasteners.
- Includes 9 holes for screwdriver storage and a 15 pc. cut-out to hold sockets.



NEW

130 lb.
LOAD CAPACITY

W85039*

Inner: 1 Master: 1

REMOVABLE TRAY FOR MOBILE USE

1000LM LI-ION WORK LIGHT W/POWER BANK

- Professional Grade Licensed COB [Chip-On-Board] Strip.
- Lightweight and durable ABS construction.
- Strong Magnet on the back and hook for hands free operation.
- 5 Output Settings
- Water resistant rated IP44.
- Powered by built-in (2) 3.7V 1500mAh 18650 Lithium-Ion rechargeable battery (included).
- Micro USB charging cable included



1000 LUMENS



189*

Inner: 6 Master: 24

400+LM LI-ION NECK LIGHT

- Features two individually controlled lighted ends for positioning light wherever you need it.
- Flexible neck is 19-1/2 in. long (49.5 cm) and stays in whatever shape or configuration you place it in.
- Dual power buttons independently control each spotlight and area light.
- Internal lithium-ion battery with 650mAh capacity provides up to 3 hours of operation.
- Specifications: 408 maximum lumen output, 3-hour runtime, 3-hour charging time, 4.7 oz. (162 g), 3.7V 650mAh battery, 40 in. USB-C cable (1 M)



2 INDIVIDUALLY CONTROLLED LIGHTED ENDS

NEW

400+ LUMENS



W2687*

Inner: 6 Master: 48

2 PK. 300+LM FIREPOINT X FLASHLIGHT SET

- Adjustable DuoFocus beam goes from spot to flood.
- Warm white LED provides better color representation and a more natural light.
- Water and impact resistant anodized tactical aluminum housing.
- Includes two padded nylon pouches with belt loop.
- Specifications: 302 lumens on high, 81 lumens on low, 2.25 hour runtime on high, 15 hour runtime on low, 141m/70 beam, 124mm total length.
- Operates on 3AAA batteries or 18650 li-ion battery (sold separately)



300+ LUMENS

W2671*

Inner: 1 Master: 20

150+LM RUBBER GRIP LI-ION FLASHLIGHT

- Ergonomic wide handle design provides a more comfortable grip and prevents light from rolling away.
- Rubberized head and grip are tactile and shock absorbent.
- High output LED never needs replacing and creates a bright spot and broad flood of light.
- Built-in 14500, 500mAh capacity lithium ion battery, and 3 in. (8 cm) USB-C charging cord included.



150+ LUMENS

NEW

W2431*
Inner: 10 Master: 40

*California Residents Prop 65 warnings see page 48.

VORTEX™

Performance Tool®

TIRE INFLATOR PROGRAM

More Details at wilmarllc.com/vortex

NEW



SCAN FOR
DETAILS



- Vortex tire inflators are equipped with an upgraded metal cylinders for faster heat dissipation, lower noise, and longer service life.
- Equipped with a 10 ft. (3 m) power cord and 18 in. (W7900) or 24 in. (W7901, W7902, W7903 & W7904) high-pressure braided air hose.
- Easy to use lever-locking air chuck is PMS tire sensor safe and includes 3 air adapters: sports ball needle, raft nozzle, and toy inflator.
- Built-in LED light turns on as soon as power is connected to verify connection and provide visibility.

ON-BOARD STORAGE

Keep your hose conveniently tucked away with a compartment for accessories.

Included: 3 pc. nozzle set & replacement 15A fuse

12V RAPID TIRE INFLATOR W/LED LIGHT

- Inflates a standard 195/65/R15 car tire from 25 to 35 PSI in about 90 seconds and a completely flat tire to 35 PSI in under 6 minutes.
- Large, easy to read, pressure gauge



W7901*
Inner: 1 Master: 20

MAX READING
OF 100 PSI



NEW

12V RAFT & TIRE INFLATOR W/LED LIGHT

- Our most versatile 12v inflator has a 2-motor design for use with high pressure tires or larger inflatables.
- Inflates a standard 195/65/R15 car tire from 25 to 35 PSI in about 90 seconds and a completely flat tire to 35 PSI in under 6 minutes.
- 15 in. high-volume air hose and 2 size adapters are useful for inflating/deflating larger rafts, balls, mattresses or toys.

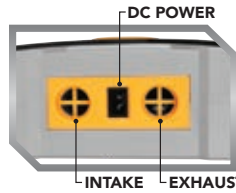

MAX READING
OF 100 PSI



HIGH VOLUME



W7903*
Inner: 1 Master: 20

NEW

12V DIGITAL TIRE INFLATOR W/AUTO-STOP

- Inflates a standard 195/65/R15 car tire from 25 to 35 PSI in about 90 seconds and a completely flat tire to 35 PSI in under 6 minutes.
- Bright LED digital pressure gauge is easy to read, day or night, and switches between PSI, bar, and kg/cm² with a push of a button.
- The digital gauge will automatically shut off when it reaches the preset value.



W7902*
Inner: 1 Master: 20

MAX READING
OF 100 PSI

DIGITAL
AUTO SHUT-OFF



NEW

AC/DC POWERED TIRE INFLATOR W/AUTO-STOP

- This versatile tire inflator / compressor can use either 120V AC outlet power or the 12V accessory outlet in your car.
- Inflates a standard 195/65/R15 car tire from 25 to 35 PSI in about 45 seconds and completely flat tire to 35 PSI in under 5 min.
- Bright LED digital pressure gauge is easy to read, day or night, and switches between PSI, bar, and kg/cm².
- The digital gauge will automatically shut off the inflator when it reaches the preset value.

W7904*
Inner: 1 Master: 20

NEW



MAX READING
OF 100 PSI

DIGITAL
AUTO SHUT-OFF



DC/AC POWER

12V COMPACT TIRE INFLATOR W/ LED LIGHT

- Inflates a standard 195/65/R15 car tire from 25 to 35 PSI in under 2 minutes and a completely flat tire to 35 PSI in 7 minutes.
- Large, easy to read, pressure gauge



W7900*
Inner: 1 Master: 20

MAX READING
OF 60 PSI



NEW



UNIVERSAL WRENCHES

- Time-saving design uses a spring-loaded jaw that automatically adjusts to standard and metric fasteners - no collar or wheel to adjust to the right size.
- Quick and easy ratcheting action allows continuous operation without having to remove and reposition the wrench after each turn.
- Compatible with most types of fasteners including hex head, spline, star, and square head nuts, bolts, screws, and even damaged fasteners.
- Drop forged chrome vanadium construction with a rust-resistant poly coating.
- Ergonomic TPR handle provides comfort and control.

12 IN. WJ30798*

Inner: 6 Master: 36

Adjusts to standard and metric fasteners
3/4 - 1-11/16 in. (19 - 43 mm) in diameter

10 IN. WJ30799*

Inner: 6 Master: 48

Adjusts to standard and metric fasteners
9/16 - 1-3/8 in. (15-35 mm) in diameter

8 IN. WJ30797*

Inner: 6 Master: 60

Adjusts to standard and metric fasteners
3/8 - 1 in. (9 - 25 mm) in diameter

**AUTOMATICALLY
ADJUSTS TO SAE &
METRIC FASTENERS**

NEW



**ERGONOMIC TPR HANDLE
PROVIDES COMFORT & CONTROL**

SAE

METRIC

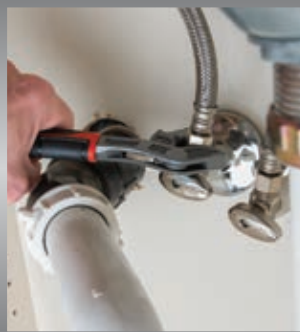

9 PC. MASTER 10MM SOCKET & WRENCH SET

- Nine different versions of the most popular size socket/wrench on the market.
- Features deep and shallow wall, universal, impact in assorted 1/4 in. and 3/8 in. drive sizes, and a combination wrench.
- Chrome vanadium alloy steel construction for strength and durability.
- Rounded corners for a tighter grip and recessed edges that reduce fastener rounding.
- Polished nickel chrome and black phosphate finishes resist corrosion.



NEW



WJ39001*

Inner: 6 Master: 36

Includes: 1/4 in. Dr. 10 mm 6 pt. socket 1/4 in. Dr. 10 mm 6 pt. impact socket, 1/4 in. Dr. 10 mm 6 pt. deep wall socket; 1/4 in. Dr. 6 pt. universal socket, 3/8 in. Dr. 10 mm 12 pt. socket, 3/8 in. Dr. 6 pt. universal socket, 3/8 in. Dr. 10 mm 6 pt. impact socket, 3/8 in. Dr. 10 mm 6 pt. deep wall socket, 10 mm combination wrench

SMALL TUBES - 9-1/4" x 3-1/2"

12 PC. TRIM REMOVAL KIT IN JAR

- Great kit for removing car stereo trim, door/dashboard panels, moldings, trim clips, or any other plastic interior or exterior components
- 12 multi-function trim tools provide 22 different end designs for removing interior and exterior trim, panels, and fasteners
- Made of durable nylon reinforced polypropylene that resists bending and breaking

WJ1760*

Inner: 6 Master: 36



20 PC. SCREWDRIVER KIT IN JAR

- Alloy steel blades with satin finish and magnetic tips
- Non-slip molded grips provide better comfort and control
- 10 full size screwdrivers: 1/4" x 5", 3/16" x 5", 1/8" x 4", 3/32" x 3", 1/4" x 1-1/2" slotted; #2 x 4", #1 x 5", #0 x 4", #0 x 3", #2 x 1-1/2" Phillips
- 10 precision screwdrivers: 3/32" x 1-1/2" and 1/8" x 1-1/2" slotted; #0 x 1-1/2" and #00 x 1-1/2" Phillips; T5, T6, T7, T8, T9 and T10 x 1-1/2" Star

WJ1761*

Inner: 6 Master: 36



54 PC. ELECTRICAL KIT IN JAR

- Wire stripper crimper strips and crimps 10-22 AWG, and cuts 4-40 to 10/32 soft steel fasteners
- Voltage tester determines if voltage is present and features insulated probe for 6V and 12V systems, and test lead with alligator clip
- Continuity tester determines a closed or open circuit, and test lead with alligator clip and 1AA battery operation (not included)
- Contents: Wire stripper/crimper; voltage tester, 3/4" x 30" electrical tape, 30 assorted electric connectors, 20 4" cable ties, continuity tester

WJ1762*

Inner: 6 Master: 36



11 PC. SAFETY KIT IN JAR

- Safety glasses feature adjustable length arms and meet ANSI Z87.7-2003
- Knit gloves are lightweight, breathable, flexible, and feature dotted grip for a better grip
- (5) Dust masks for non-volatile solid and/or liquid irritants such as dust, dirt, mists and droplets
- Earplugs designed to reduce noise by up to 29db
- 2-7/8" x 30" Duct tape for anything and everything

WJ1763*

Inner: 6 Master: 36



LARGE TUBES - 12-3/8" x 4-5/8"

10 PC. HOOK & PICK KIT IN JAR

- Chrome vanadium steel shafts with comfortable non-slip molded grips
- LED magnetic pickup tool: features bright LED light, 8lb capacity magnet and cushion grip handle
- Telescoping pickup tool extends 27-1/2" to retrieve objects from confined areas. Requires (3) AG13 button cell batteries (included)
- Contents: (5) 10" (25.4cm) tools with 4" grips: straight pick, curved hook, 45° hook, 90° pick, and 1" scraper; (4) 6.5" (16.5cm) picks with 3.5" grips: straight; curved, 45°, and 90°

WJ1771*

Inner: 4 Master: 16



31 PC. HOMEOWNER KIT IN JAR

- 8oz fiberglass claw hammer with drop forged head and comfortable rubber grip
- 9" triple vial torpedo level with magnetic base
- Retractable aluminum utility knife with blade
- 12" x 1/2" locking tape measure
- 1/4" hex magnetic bit and socket driving system features 20 1" power bits, and 6 1/4" drive sockets
- Bit sizes: 3/16", 1/4", 9/32" slotted; #0, #1, #2, #3 Phillips; 1/4" Drive adapter; T10, T15, T20, T25 Star; Metric Hex 3, 4, 5 & 6 mm, SAE Hex: 3/32, 1/8, 5/32 & 3/16"
- 1/4" Dr. socket sizes: SAE: 5/16, 3/8, 7/16, Metric: 10, 12, 13mm

WJ1773*

Inner: 4 Master: 16



SCREWDRIVERS



61 PC. SCREWDRIVER & BIT SET

- FREE STANDING STORAGE/ORGANIZING RACK - features bit storage and removable magnetizer/demagnetizer
- Heat treated alloy steel blades with satin finish, magnetic tips and non-slip molded grips
- Most popular Phillips, slotted, star and square sizes
- Storage/organizing rack

**MAGNETIZER/
DEMAGNETIZER**

W1731*
Inner: 1 Master: 4



39 PC. SCREWDRIVER SET W/RACK

- Organizing rack features built-in bit holders and magnetizer/demagnetizer
- Chrome vanadium blades and power bits
- Comfortable non-slip molded grips
- Satin finish with magnetic tips
- Magnetic Bit Driver
- Storage/Organizing Rack

W1727*
Inner: 1 Master: 6

**MAGNETIZER/
DEMAGNETIZER**



GO-THRU SCREWDRIVER SET

- Color coded, ergonomic non-slip molded grips for improved comfort and control
- High strength go-through shank design features smooth striking face end caps
- Heat-treated satin plated hexagonal shafts with black magnetic tips



12 PC. W1741*

Inner: 1 Master: 4
Sizes: 1/4" x 6", 3/8 x 6", 5/16 x 6"
Slotted; #1 x 6", #2 x 6", #3 x 6"
Phillips; T25 x 6", T27 x 6", T30 x 6"
Star; S1 x 6", S2 x 6", S3 x 6"



**FEATURES
STRIKING CAPS**

**COLOR CODED
HANDLES**



6 PC. W1740*

Inner: 1 Master: 6
Sizes: 3/16 x 6", 1/4 x 6", 5/16 x 6"
Slotted; #1 x 6", #2 x 6", #3 x 6" Phillips



**ALL FEATURED
MAGNETIC TIPS**

NEW

9 PC. W1742*

Inner: 1 Master: 6
Sizes: 1/8 x 3 in., 1/4 x 6 in., 5/16 x 6 in.,
3/8 x 6 in. Slotted; #0 x 3 in. #1 x 3 in., #2
x 6 in., #3 x 6 in. Phillips; T25 x 3 in. Star



RATCHETING SCREWDRIVER

- High torque ratchet mechanism with 3-way ratcheting action: forward, lock, reverse in a compact stubby design
- Rubber cushion grip handle. Chrome vanadium steel construction
- Phillips: #1 and #2. Slotted: 3/16 and 1/4". Star: T15 and T20. Square: S2

BULK ITEM



20149*
Inner: 4 Master: 24

12 PC. BIT DRIVER SET

- Oversized handle for improved torque.
- Comfortable non-slip molded grip.
- Built-in storage inside handle.
- 6-1/2" flexible bit extension.
- Bit sizes: Phillips #1, 2, 3; Slotted 5/32, 3/16, 1/4; Star T10, T15, T20, 1/4" adapter

W1728*
Inner: 12 Master: 24



5 PC. LOW PROFILE SCREWDRIVER

- Low profile design feature 3/8 inch (10mm) clearance, and a 15° offset angle for improved access for hard to reach fasteners.
- Corrosion resistant heat treated steel handles with durable S2 alloy steel bits.
- Includes key ring & carabiner clip for convenient organization and compact storage.
- Vacuum tray keeps everything organized.

COLOR CODED

SCREWDRIVERS W30977*

Inner: 12 Master: 96
Includes 5 popular sizes: Phillips #1, #2, Pozzi
PZ1, PZ2, and slotted 3/16 inch (6mm).

STAR W30978*

Inner: 12 Master: 96
Includes 5 popular star sizes:
T20, T25, T27, T30, T40.



**OFFSET DESIGN FOR
IMPROVED ACCESS**



52 PC. 1/4" 3/8" 1/2" SOCKET SET

- 3/8" and 1/2" dr. ratchets, extension bar, adapter, 1/4" spinner handle
- 1/4, 3/8 and 1/2" dr. sockets: 5/32 - 7/8" and 4 - 17mm
- Storage case

WJ1172*
Inner: 1 Master: 5



40 PC. 1/4" & 3/8" DR. SOCKET SET

- Ratchet, extension bar, 1/4" spinner handle, spark plug socket, adapter and more
- 1/4" and 3/8" dr. socket sizes: 5/32" to 3/4" and 4mm to 17mm
- Sturdy blow molded case

WJ1173*
Inner: 1 Master: 10



60 PC. 1/4" & 3/8" DR. SOCKET SET

- 3/8" dr. ratchet, 3" extension
- 1/4" dr. spinner handler, coupler
- 27 piece 3/8" and 1/4" dr. sockets
- 3/8" F to 1/4" M adapter
- 26 piece 1" bits

WJ1168*
Inner: 6 Master: 12



85 PC. SOCKET SET

- Drop forged chrome plated carbon steel
- Wide range of SAE and Metric sockets in 3 drive sizes
- Storage / Carrying Case

WJ1183*
Inner: 1 Master: 5



94 PC. GARAGE TOOL SET

- Versatile tool assortment for repairs around your garage
- 3/8" drive reversible ratchet
- SAE and metric sockets and accessories
- Pliers, adjustable wrench, screwdrivers, magnetic bit driver,
- Assorted hex bits and hex key wrenches

WJ1538*
Inner: 1 Master: 4



107 PC. HOME & AUTO TOOL SET

- Versatile tool assortment for repairs around your garage
- 3/8" drive reversible ratchet
- SAE and metric sockets and accessories
- Pliers, wrenches, bit driver hammer, tape measure, knife, adjustable wrench, precision screwdrivers, hex key wrenches

WJ1532*
Inner: 1 Master: 4



123 PC. MECHANIC'S TOOL SET

- Comprehensive selection of tools including sockets, wrenches, pliers, screwdrivers, hex keys and more
- Features SAE and metric sizes for a wide range of applications
- Blow molded storage/carrying case
- Extremely versatile set for repairs around your home, auto garage, workshop, RV or boat

WJ1801*
Inner: 1 Master: 3



45 PC. STUBBY SET

- 72 gear teeth dual drive ratchet: 1/4" and 3/8" drives in one ratchet
- Ratcheting screwdriver: clockwise, counter clockwise and locking positions
- Stubby adjustable wrench has 1" rule on head for precision adjustments
- Alloy steel construction for strength and durability
- Comfortable cushion grip handles

WJ39000*
Inner: 6 Master: 12



47 PC. 1/4" DR. SOCKET SET

- Drop forged carbon steel with corrosion resistant chrome plated finish
- Wide range of standard sockets and bit sockets in SAE and Metric sizes
- Ratchet, bit driver and sockets give you a comprehensive nut, bolt, and screw driving system

WJ1177*
Inner: 5 Master: 20



75 PC. HOMEOWNER'S TOOL SET

- 8 oz Steel Hammer with Rubber Grip
- 2 Screwdrivers: 1/4" x 4" slotted, #2 X 4" Phillips
- 6 Screwdrivers: 1/16, 3/32, 1/8" slotted, #0, #00, #000 Phillips
- 12 ft Fractional readout tape measure
- Snap-blade Knife
- Torpedo Level
- Assorted Fastener Kit
- Storage/Carrying Case

WJ1543*
Inner: 1 Master: 10



38 PC. COMPACT AUTO TOOL KIT

- Perfect to keep in your trunk in case of emergencies, this Ki can address a multitude of problems with cars
- With so many tools in one small kit, you'll have whatever you need wherever you go
- Nylon case closes securely and is tough enough to take to any job
- Includes a bit driver and bits, sockets and accessories, adjustable wrench, pliers, compact flashlight, tire gauge, 12-volt tester and more in a convenient and compact nylon zippered case

WJ1197*
Inner: 6 Master: 24



*California Residents Prop 65 warnings see page 48.

WRENCHES & PLIERS

24 PC. SAE AND METRIC COMBO WRENCH SET

- Heat treated alloy steel.
- Raised panel design.
- Roll pouch for storage.
- SAE sizes: 1/4, 5/16, 3/8, 7/16, 1/2, 9/16, 5/8, 11/16, 3/4, 13/16, 3/4, and 1 in.
- Metric sizes: 7, 8, 9, 10, 11, 12, 13, 14, 15, 18, 19, and 22 mm



NEW



SAE & METRIC

W1074*
Inner: 1 Master: 6

32 PC. SAE & METRIC WRENCH SET

- Mirror polished chrome vanadium steel
- SAE: 1/4, 5/16, 11/32, 3/8, 7/16, 1/2, 9/16, 5/8, 11/16 & 3/4"
- Stubby: 5/16, 3/8, 7/16, 1/2, 9/16 & 5/8"
- Metric: 6, 8, 10, 11, 12, 13, 14, 15, 17 & 18 mm
- Stubby: 10, 11, 12, 13, 14 & 15 mm

W1099*
Inner: 1 Master: 5



7-IN-1 RATCHETING WRENCH SETS

- Versatility - Socket insert system provides 7 different sizes in one compact package.
- Flexibility - Head pivots a full 180° for operation at any angle giving you access to confined areas.
- Low profile head for access in tight spaces.
- 72 Gear teeth for 5° sweep - flip wrench over to reverse direction.
- Drop forged chrome vanadium steel with mirror polished finish is durable and easy to clean up.

Inner: 12 Master: 48

REUSABLE CASE

SAE
W30648*

Sizes: 5/16", 3/8", 7/16",
1/2", 9/16", 5/8", 3/4"

METRIC
W30649*

Sizes: 8, 10, 12, 13,
14, 17, 19 mm



SAE & METRIC

22 PC. COMBINATION WRENCH SET

- Polished chrome vanadium steel construction
- Handy storage rack
- SAE sizes: 1/4, 5/16, 3/8, 7/16, 1/2, 9/16, 5/8, 11/16, 3/4, 13/16 and 7/8"
- Metric sizes: 9, 10, 11, 12, 13, 14, 15, 16, 17, 18 and 19mm

SAE & METRIC



W1069*
Inner: 2 Master: 8

22 PC. COMBINATION WRENCH SET

- Chrome vanadium steel construction.
- Full pattern raised panel design.
- Chrome plated finish.
- Handy storage rack.
- Sizes: SAE: 1/4, 5/16, 3/8, 7/16, 1/2, 9/16, 5/8, 11/16, 3/4, 13/16 and 7/8", Metric: 6, 7, 8, 9, 10, 11, 12, 13, 14, 17 and 19mm.

SAE & METRIC



W1084*
Inner: 1 Master: 6

11" UNIVERSAL DOUBLE BOX WRENCH

- Self-tightening universal box wrench features a total of 18 tapered openings to fit a wide range of fastener sizes and styles
- Fits standard hex head fasteners from 5/16 to 7/8 inch and 8mm to 22mm in diameter
- Unique open-end design also fits eye-bolts, hooks, J-bolts, cup hooks, wing nuts, square end fasteners up to 1.5 in (38mm) long
- Low profile, extended length pattern allows for maximum torque, in tight space
- Total length: 10-3/4" (270mm); 5/16" (8mm) profile

SAE & METRIC

18 TOOLS IN !!

W30789*
Inner: 8 Master: 48

19 PC. 3/8" DR. BLACK SOCKET SET

- 18 double plated black sockets feature both SAE and Metric sockets in popular sizes
- Ratchet features indestructible protective coating, chrome vanadium steel core with precision 72 gear teeth
- 6pt SAE Sizes: 5/16, 3/8, 7/16, 1/2, 9/16, 5/8, 11/16, 3/4 and 13/16"
- 6pt MM sizes: 9, 10, 11, 12, 13, 14, 15, 17 and 19mm

W38337*
Inner: 6 Master: 24



8 PC. 3/8" DR. SCREWDRIVER BIT SOCKET SET

- Chamfered edges are easier to insert and remove from recessed fasteners
- Heat treated chrome vanadium alloy steel sockets, and S2 steel bits for strength and durability
- Polished nickel chrome plated finish resists corrosion
- 3/8" Dr. driver bit socket sizes: 1/8, 3/16, 1/4, 5/16 in. Slotted; #0, #1, #2, #3 Phillips
- Includes steel socket clip rail

W38860*
Inner: 6 Master: 48



SOCKET RAIL INCLUDED

9 PC. 1/2" D. 12PT SOCKET SETS

- Recessed edges
- Socket openings are designed to reduce fastener rounding
- Chrome vanadium alloy steel construction for strength and durability
- Polished nickel chrome plated finish resists corrosion

METRIC
W32800*

Inner: 6 Master: 12
12pt. std. Sizes: 12, 13, 14, 15,
16, 17, 18, 19 and 22mm

SAE
W32500*

Inner: 6 Master: 12
12pt. std. Sizes: 1/2, 9/16, 5/8,
11/16, 3/4, 13/16, 7/8, 15/16 and 1"



SPRING LOADED



WIRE CUTTER



CRIMPER/STRIPPER



MULTIFUNCTION PLIERS

- Multifunction pliers and strippers allow you to cut, strip, crimp, twist, and grip for a range of electrical projects
- Hardened cutting edges cut steel wire up to 2mm diameter, and iron or copper wire up to 3mm
- Crimper for insulated and non-insulated connectors from 0.75-6mm
- Professional grade forged Cr-V construction with gripping teeth for use as a wrench

8-1/2" LINESMAN

W86508*
Inner: 6 Master: 36
 Strip and cut 8-16 AWG solid wire and 10-18 AWG stranded wire

HIGH QUALITY CONSTRUCTION

SPRING LOADED

2-IN-1

ERGONOMIC COMFORT GRIPS



ENHANCED STRIPE PACKAGING

8-1/2" LONG NOSE

W86507*
Inner: 6 Master: 36
 Strip and cut 10-16 AWG solid wire and 12-18 AWG stranded wire

7-1/2" DIAGONAL

W86509*
Inner: 6 Master: 36
 Strip and cut 10-16 AWG solid wire and 12-18 AWG stranded wire

2-IN-1 DUAL JAW QUICK PLIERS

- Unique design switches easily from long nose, wire stripping/cutting pliers, flat/curved gripping pliers
- Durable chrome vanadium construction for improved cutting, gripping, turning, holding, and more
- Integrated slide lock engages to keep pliers in closed position
- Total length: 7-1/4" (18.4cm), 0.75" (19mm) jaw capacity, 10GA cutting capacity, strips 12GA and 16GA wire

COMFORT MOLDED GRIPS

REVERSIBLE



W1105*
Inner: 6 Master: 36



6-1/2" MULTIFUNCTION FLUSH CUTTING PLIERS

- Multifunction flush cutting and stripping pliers allow you to cut, strip, crimp, and shear for a range of electrical projects.
- Hardened cutting edges cut wire up to 2 mm diameter (5/64 in.).
- Strip and cut 10-20 AWG solid wire.
- Professional grade steel construction.
- Crimper for insulated and non-insulated connectors from 0.8-2.6 mm (1/32-7/64 in.).
- Ergonomic non-slip molded grips with spring loaded handles for quick action

W86510*
Inner: 12 Master: 72



NEW



10 PC. PLIERS SET WITH RACK

- FREE STANDING STORAGE/ORGANIZING RACK - Can also be hung on pegboard
- Double dipped cushion grip handles for comfort and control
- Drop forged and heat-treated alloy steel construction
- Machined jaws for maximum gripping strength
- Cutting pliers feature induction hardened cutting edges for added durability
- Contents: 4-1/2 in. diagonal, 5 in. long nose, 5-1/2 in. needle nose, 6 in. slip joint, 6 in. diagonal, 6 in. long nose, 7 in. linesman, 7 in. straight locking, 8 in. groove joint, 6 in. adjustable wrench

W1705*
Inner: 2 Master: 4

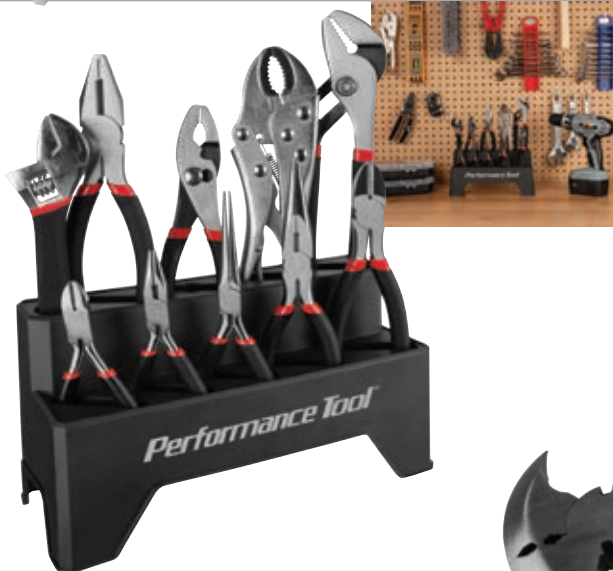

2 PC. PLIERS SET

- Drop forged alloy steel construction
- Ergonomic cushion grip handles for comfort and control
- 10 in. (250mm) fence pliers feature hammer head, pick end and wire cutters
- 8 in. (200mm) diagonal pliers feature precision cutting jaws, and serrated crimping portion on handles

W1722*
Inner: 6 Master: 12



*California Residents Prop 65 warnings see page 48.

THREAD REPAIR



1/2" DR. X-TRAX SOCKET SETS

- Patented design removes old, stripped, rusted or damaged nuts and bolts up to 85% rounded
- Deep wall, impact grade chrome vanadium steel for strength and durability
- Corrosion and oil resistant black phosphate finish
- Large size laser etching for easy identification
- Innovative storage/carrying case features dual hinge design for easy access to all 11 sockets

SAE
WJ32916*
 Inner: 4 Master: 8
 Sizes: 3/8, 7/16, 1/2, 9/16,
 5/8, 11/16, 3/4, 13/16, 7/8,
 15/16, 1 in

METRIC
WJ32917*
 Inner: 4 Master: 8
 Sizes: 10, 12, 13, 14, 15,
 16, 17, 18, 19, 21, 22mm



INNOVATIVE CARRYING CASE

PERFECT FOR STUBBORN LUG NUTS



5 PC. BOLT EXTRACTOR SET

- Spiral gripping edges remove old, stripped, rusted or painted nuts and bolts
- Chrome molybdenum steel with black manganese phosphate finish for strength and durability
- Sizes: 5/16 in. (8mm), 3/8 in. (10mm), 1/2 in. (13mm), 11/16 in., 3/4 in. (19mm)*
- Includes 3/8 in. drive socket storage rail

STANDARD
WJ38921*
 Inner: 1 Master: 40



SOCKET RAIL INCLUDED



5 PC. BOLT EXTRACTOR ADD-ON SET

- Spiral gripping edges remove old, stripped, rusted or painted nuts and bolts
- Chrome molybdenum steel with black manganese phosphate finish for strength and durability
- Sizes: 7/16 in. (11mm), 12mm, 9/16 in. (14mm), 15mm, 5/8 in. (16mm)*
- Includes 3/8 in. drive socket storage rail

ADD-ON
WJ38922*
 Inner: 1 Master: 40



PAIR WITH WJ38921 & WJ38922

DEEP
WJ38923*
 Inner: 1 Master: 24

11 PC. X-TRAX HEX BIT SETS

- Patented gripping edges work with standard recessed hex fasteners, or use at an angle to remove old, stripped, rusted or painted fasteners
- Chrome vanadium steel for strength and durability
- Chrome nickel and black oxide finish resists corrosion
- Includes socket storage rail

SAE WJ38790*
 Inner: 4 Master: 40

SAE sizes: 1/4 inch Dr. x 37mm: 1/16, 5/64, 3/32, 7/64, 1/8, 5/32 inch; 3/8 inch Dr. x 48mm: 3/16, 7/32, 1/4, 5/16, 3/8 inch

METRIC WJ38791*
 Inner: 4 Master: 40

1/4 inch Dr. x 37mm: 1.5, 2, 2.5, 3, 4, 4.5mm;
 3/8 inch Dr. x 48mm: 5, 6, 8, 10, 12mm



SOCKET RAIL INCLUDED



4 PC. X-TRAX SCREW REMOVER SET

- Reverse thread design with dual tips quickly remove stripped or broken screws and broken off bolts without damaging surrounding area
- Upgraded quality M2 6542 tungsten alloy is harder than most extractors
- 1/4 in. and 5/16 in. hex shank screw extractors work with any adjustable chuck drill
- Designed to drill out and remove even the most stubborn stripped, damaged, embedded, rusted or painted-over screws and bolts



EASILY REMOVE DAMAGED SCREWS

WJ491*
 Inner: 20 Master: 80

Sizes included work with the following size damaged fasteners: #1 (#4-7 screws; #10/5mm bolts), #2 (#8-10 screws; 1/4 in./6mm bolts), #3 (#11-14 screws; 5/16 in./8mm bolts), #4 (16-24 screws; 3/8 in./10/ bolts)

Sold in INNER QTY.

CASE INCLUDED

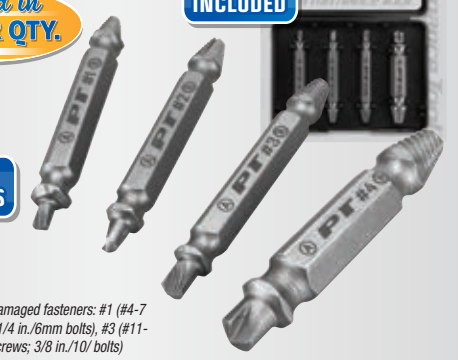

42 PC. MASTER THREAD RESTORER KIT

- Contains commonly found automotive and household hardware sizes.
- Taps and dies are Metric/SAE UNC and SAE UNF.
- Hex sized taps and dies provide multiple tool options for turning the taps and dies.
- Thread gauges make it easy to choose the correct sized tool.
- Contents: 21 pc. repair dies: UNF 1/4, 5/16, 3/8, 7/16, 1/2, 9/16, 5/8 in. UNC 1/4, 5/16, 3/8, 7/16, 1/2, 9/16, 5/8 in. Metric 6 x 1.00, 8 x 1.25, 10 x 1.25, 10 x 1.50, 12 x 1.25, 12 x 1.5, 12 x 1.75 mm 19 pc. repair taps: UNF 1/4, 5/16, 3/8, 7/16, 1/2, 9/16 in. UNC 1/4, 5/16, 3/8, 7/16, 1/2, 9/16 in. Metric 6 x 1.00, 8 x 1.25, 10 x 1.25, 10 x 1.5, 12 x 1.25, 12 x 1.5, 12 x 1.75 mm 1 pc. Metric Thread Gauge 1 pc. SAE Thread Gauge

WJ8660*
 Inner: 10 Master: 20

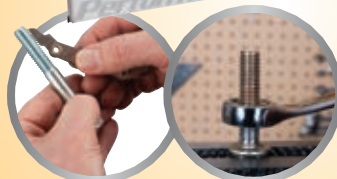

NEW

THREAD REPAIR KIT M6-1.0

- M6-1.0 thread size.
- Use with drill bit size 1/4 in. (6.3 mm).
- Restore threads to the original sizing.
- Includes: (1) 4241 HSS M6-1.0 UNC tap, (3) 304 stainless steel inserts, and (1) Install/punch tool

W86901*
Inner: 24
Master: 144

NEW



10 PK INSERTS
W86911*
Inner: 24
Master: 240

THREAD REPAIR KIT M8-1.25

- M8-1.25 thread size.
- Use with drill bit size 21/64 in. (8.3 mm).
- Restore threads to the original sizing.
- Includes: (1) 4241 HSS M8-1.25 UNC tap, (3) 304 stainless steel inserts, and (1) Install/punch tool

W86902*
Inner: 24
Master: 144

NEW



10 PK INSERTS
W86912*
Inner: 24
Master: 240

THREAD REPAIR KIT M10-1.50

- M10-1.50 thread size.
- Use with drill bit size 13/32 in. (10.4 mm).
- Restore threads to the original sizing.
- Includes: (1) 4241 HSS M10-1.50 UNC tap, (3) 304 stainless steel inserts, and (1) Install/punch tool

W86903*
Inner: 24
Master: 144

NEW



10 PK INSERTS
W86913*
Inner: 24
Master: 240

THREAD REPAIR KIT M14-1.25

- M14-1.25 thread size
- Use with drill bit size 9/16 in. (14.5 mm)
- Restore threads to the original sizing
- Includes: (1) 4241 HSS M14-1.25 UNC tap, (3) 304 stainless steel inserts, and (1) Install/punch tool

W86904*
Inner: 24
Master: 48

NEW



10 PK INSERTS
W86914*
Inner: 24
Master: 240

SPARK PLUG REPAIR KIT M14-1.25

- M14-1.25 thread size
- Tapered reamer replaces the need for a drill bit
- Restore threads to the original sizing
- Includes: (1) 4241 HSS Tapered reamer, (3) 503 Stainless steel inserts - 5/16 in., 7/16 in., and 5/8 in. lengths, and (1) Install/punch tool

W86910*
Inner: 24
Master: 48

NEW



6 PK INSERTS
W86915*
Inner: 24
Master: 240

THREAD REPAIR KIT 1/4-20

- 1/4-20 thread size.
- Use with drill bit size 17/64 in. (6.7 mm).
- Restore threads to the original sizing.
- Includes: (1) 4241 HSS 1/4-20 UNC tap, (3) 304 stainless steel inserts, and (1) Install/punch tool

W86905*
Inner: 24
Master: 144

NEW



10 PK INSERTS
W86916*
Inner: 24
Master: 240

THREAD REPAIR KIT 5/16-18

- 5/16-18 thread size.
- Use with drill bit size 21/64 in. (8.3 mm).
- Restore threads to the original sizing.
- Includes: (1) 4241 HSS 5/16-18 UNC tap, (3) 304 stainless steel inserts, and (1) Install/punch tool

W86906*
Inner: 24
Master: 144

NEW



10 PK INSERTS
W86917*
Inner: 24
Master: 240

THREAD REPAIR KIT 3/8-16

- 3/8-16 thread size.
- Use with drill bit size 25/64 in. (9.9 mm).
- Restore threads to the original sizing.
- Includes: (1) 4241 HSS 3/8-16 UNC tap, (3) 304 stainless steel inserts, and (1) Install/punch tool

W86907*
Inner: 24
Master: 144

NEW



10 PK INSERTS
W86918*
Inner: 24
Master: 240

THREAD REPAIR KIT 7/16-14

- 7/16-14 thread size.
- Use with drill bit size 29/64 in. (11.6 mm).
- Restore threads to the original sizing.
- Includes: (1) 4241 HSS 7/16-14 UNC tap, (3) 304 stainless steel inserts, and (1) Install/punch tool

W86908*
Inner: 24
Master: 144

NEW



THREAD REPAIR KIT 1/2-13

- 1/2-13 thread size.
- Use with drill bit size 17/32 in. (13 mm).
- Restore threads to the original sizing.
- Includes: (1) 4241 HSS 1/2-13 UNC tap, (3) 304 stainless steel inserts, and (1) Install/punch tool

W86909*
Inner: 24
Master: 96

NEW



TAPE MEASURES

Lightweight, crystal clear and impact resistant polycarbonate housing

Auto-retracting blade with high-carbon and heat-treated rewind spring

Easy to operate thumb lock, steel belt clip and vinyl lanyard included



CASE

Lifetime Warranty

CLEAR TAPE MEASURE SETS

- Clear polycarbonate housing is lightweight and impact resistant with high-vis accent case colors
- Highly accurate SAE and Metric measurements
- Auto-retracting blade glides smoothly both in and out
- Easy to operate thumb lock secures blade tightly until it is released to retract the tape
- Stamped steel belt clip holds tape measure securely to your pocket, belt, or tool bag

4 PC. W5039* Inner: 4 Master: 16

4 pack of different length tapes: 12 ft. x 1/2 in. (purple), 16 ft. x 3/4 in. (green), 25 ft. x 1 in. (orange), and 33 ft. x 1 in. (yellow)



2 PC. W5038*

Inner: 6 Master: 24
2 pack of different length tapes: 16 ft. x 3/4 in. (green) and 25 ft. x 1 in. (orange)



6' X 1/2" CLEAR TAPE MEASURE

- High-grade polycarbonate housing is lightweight, always crystal clear, and impact resistant
- 1/2 in. blade with 2-sided, high contrast printing and stamped steel end hook
- High accuracy SAE and Metric measurements conveniently, side-by-side, on one tape
- Auto-retracting blade glides smoothly both in and out thanks to the high-carbon, heat-treated, rewind spring



SAE MET

HANDY KEYCHAIN

W5046*
Inner: 6 Master: 72

SAE & METRIC CLEAR TAPE MEASURES

- High-grade polycarbonate housing is lightweight, always crystal clear, and impact resistant
- 2-sided, horizontal and vertical, high contrast printing and double-sided end hook for measuring from any angle
- High accuracy SAE and Metric measurements conveniently, side-by-side, on one tape
- Spring-assisted blade stop cushions hook as it retracts into case, preventing damage to the anchor rivets
- Auto-retracting blade glides smoothly both in and out thanks to the high-carbon, heat-treated, rewind spring

25 FT. X 1 IN.
W5042*
Inner: 8 Master: 48



12 FT. X 5/8 IN.
W5044*
Inner: 8 Master: 48



SAE MET

SINGLE HOOK

SAE CLEAR TAPE MEASURE

- High-grade polycarbonate housing is lightweight, always crystal clear, and impact resistant
- 2-sided, horizontal and vertical, high contrast printing and double-sided end hook for measuring from any angle
- High accuracy SAE measurements with fractional numbers every 1/8 in.
- Spring-assisted blade stop cushions hook as it retracts into case
- Auto-retracting blade glides smoothly both in and out

16 FT. X 1 IN.
W5045*
Inner: 8 Master: 48

33 FT. X 1 IN.
W5047*
Inner: 6 Master: 36

2 PC. 25 FT. X 1 IN.
W5043*
Inner: 6 Master: 24



SAE

DOUBLE HOOK

HEAVY-DUTY TAPE MEASURES

- Rubber coated, high-impact ABS case provides a secure grip for one-handed use
- Auto-lock mechanism holds the tape measure blade firmly in place as it is extended for easy handling
- Extra-wide thumb release provides full control to prevent damage to the blade or user during retraction
- Nylon coated 1 inch wide, 0.14mm thick blade delivers over 8 feet of standout
- High accuracy, MID class-2 certified measurements printed in black/red on both sides of the yellow blade
- Belt clip and woven wrist strap for convenient carrying and easy access

HIGH ACCURACY MEASUREMENTS



16 FT. X 1 IN.
W5053*
Inner: 12 Master: 36

25 FT. X 1 IN.
W5054*
Inner: 12 Master: 24

33 FT. X 1 IN.
W5055*
Inner: 12 Master: 24



RUBBER COATED ABS CASE

WRIST LANYARD

DOUBLE HOOK

24" FOLDING LEVEL

- This versatile hinged level measures precisely and quickly, even around corners, pipes, or on stairs
- With 2 horizontal, 1 vertical, and 1-45 degree bubble for precise leveling in any position
- Also can be used as a reliable straight edge around corners and obstructions
- Extended it is 23.5 in. x 2 in. x .75 in. and folded it is 4.75 in. x 3.6 in. x 3.75 in



W5703*
Inner: 16 Master: 64

USE LEVEL OR STRAIGHT EDGE AROUND CORNERS

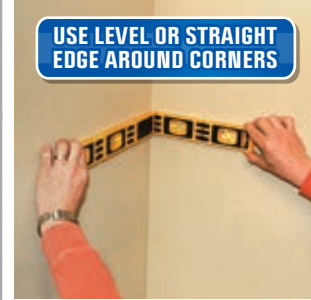

DIGITAL ANGLE FINDER



- Multi-function measuring tool displays digital angle readings from 0-999.9° and features SAE and metric straight edge markings up to 7 in, each direction, or 400mm total
- Dual scale ruler provides two 7 in. rulers for measuring two lengths simultaneously, and one continuous 400mm edge
- Easy to read 10mm and inch increments, with every 4th 1/32nd increment numbered
- Digital angle finder measures inside/outside angles and operates as T-bevel protractor



SAE & METRIC MARKINGS

W5709*
Inner: 10 Master: 60

LOCKING CONTOUR GAUGES

- Ideal for woodworking, flooring, auto bodywork, wheel arches, metalworking, plumbing work, and more where replicating an exact shape is critical
- Upgraded design features heavy-duty metal lock to hold pins in position after you copy a pattern
- Adjustable tension allows tightening or loosening of how freely the pins move



10 IN. W80142*
Inner: 6 Master: 36

5 IN. W80141*
Inner: 6 Master: 72

4-IN-1 LASER LEVEL MEASURE TOOL

- 4-in-1 multifunction measuring tool that does it all
- Built-in 8ft. (225cm) tape measure has both SAE / Metric measurements and the base of the tool has a 6" (15cm) straight line ruler
- Horizontal, vertical, and 45 degree high-visibility bubble vials
- Projects a red vertical, horizontal and cross laser light beam
- Bonus: an extra set of 3 x AG13 button-cell batteries are included



W5706*
Inner: 20 Master: 100



6" VERNIER CALIPER

- Quality steel construction provides precise inside, outside, and depth measurements up to 6 inches (150mm)
- Knurled thumb lock and sliding wheel for accurate measuring and recording
- Smooth, sliding action provides greater precision and control
- Large open view window for clear sight of measurements
- Dual scale provides standard measurements up to 1/16th of an inch, and metric scale to 1mm



MEASURES INSIDE & OUT

W80163*
Inner: 12 Master: 48

ANGLE MAKER TEMPLATE TOOL

- The perfect template tool: ideal for carpenters, wood workers, builders, craftsmen, the pro and the weekend warrior
- Timesaving tool that eliminates redundant measuring, and provides the perfect angled layout every time
- Four-sided ruler mechanism slides and locks at any desired angle to act as a reusable template
- Special tightening/loosening mechanism for one-handed operation, and easy storage
- Two 6 inch (150mm) rules, and two 10 inch (250mm) rules feature SAE and metric measurements



W5710*
Inner: 12 Master: 48

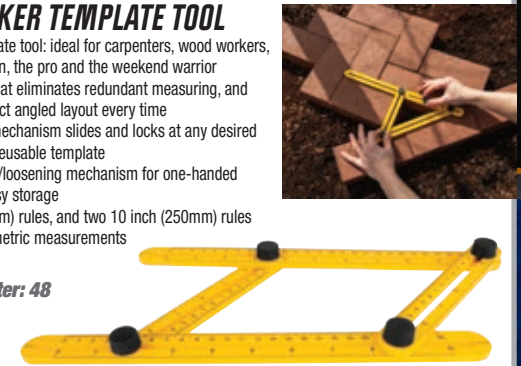

STORAGE

FENDER BUDDY FLEXIBLE TRAY

- This tray is the perfect size to transport sockets and wrenches right to the project site, 14.19 in. x 9.05 in. x 1.1 in
- Four small molded pockets for nuts and bolts
- Tray also has molded holes for drill bits, hex keys, or screwdriver bits
- Flexible tray can hold the wire, crimping tool, and the terminal connectors needed for the project
- A 3.625 in. x 2.5 in. magnetic tray for small parts, and one large compartment for your hand or power tool



W1294*
Inner: 1 Master: 6

SUPER FLEXIBLE SILICONE



SAE SOCKET TRAY HOLDERS

- Securely holds and organizes standard and deep sockets and accessories
- Pre-marked with appropriate standard size markings for quick and easy viewing



Sockets not included.

3/8 IN. DR.
W774*
Inner: 6 Master: 48
Designed for standard and deep wall SAE socket sizes: 1/4, 5/16, 3/8, 7/16, 1/2, 9/16, 5/8, 11/16, 3/4, 13/16, 7/8, 15/16, 1"



SAE

KEEP YOUR SOCKETS ORGANIZED



1/4 IN. DR.
W773*
Inner: 6 Master: 96

Designed for standard and deep wall SAE socket sizes: 3/16, 7/32, 1/4, 9/32, 5/16, 11/32, 3/8, 7/16, 1/2, 9/16, 5/8

METRIC SOCKET TRAYS

- Securely holds and organizes standard and deep sockets and accessories
- Pre-marked with appropriate metric size markings for quick and easy viewing

1/4 IN. DR.
W776*
Inner: 6 Master: 96

Designed for standard and deep wall metric socket sizes: 4, 4.5, 5, 5.5, 6, 7, 8, 9, 10, 11, 12, 13, 14, 15mm

3/8 IN. DR.
W778*
Inner: 6 Master: 48

Designed for standard and deep metric socket sizes: 6, 7, 8, 9, 10, 11, 12, 13, 14, 15, 16, 17, 18, 19, 20mm

1/2 IN. DR.
W779*
Inner: 6 Master: 48
Designed for standard and deep metric socket sizes: 10, 11, 12, 13, 14, 15, 16, 17, 18, 19, 20, 21, 22, 23, 24, 25, 27mm



2 PC. MAGNETIC TOOL HOLDER BAR

- Features strong double sided magnets so the bar will stick to most any steel surface
- Industrial looking carbon fiber textured finish will not scratch and can easily be relocated
- Length of the bar is flexible enough to contour onto a rounded surface
- 2 Tool bar holders are included that measure 11 x 2.5 x 7/16 in. thick and weight 0.5 lbs each



W12526*
Inner: 1 Master: 36



SUPER STRONG MAGNET



MAGNETIC PICK-UP MIRROR KIT

- A handy 4pc telescopic Magnetic Pick-Up & Mirror set is a necessity for every mechanics toolbox
- Small parts are easily dropped or lost, this set gives you the ability to see and pick them up
- Including a 2.25 in. round mirror on an articulated arm that extends from 9.75 in. to 36.5 in
- The magnetic retriever extends from 6.75-inches to 25-inches and has three interchangeable heads
- 2.5 lb., 3.5 lb., and 8 lb. capacity magnets, the 8 lb. is mounted to an articulated arm



HANDY BLISTER TRAY & ALUMINUM CASE

W1937*
Inner: 12 Master: 48



KEEP YOUR SOCKETS ORGANIZED

Sockets not included.



METRIC

16 SLOT WIRE PLIERS/TOOL RACK

- Keep pliers organized in your toolbox drawer or work bench
- 3/4 inch (19mm) wide slots fit most pliers, adjustable wrenches and similar size tools
- PVC coating protects pliers and prevents slippage
- Designed to accommodate both vinyl grips and injection grips
- Ideal for your work bench, garage or tool box
- Dimensions: 14 W x 5.25 D x 2.37 H inches (355 x 133 x 60mm)

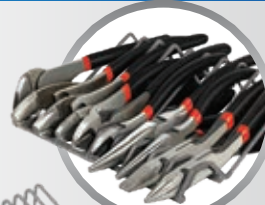

Pliers not included.

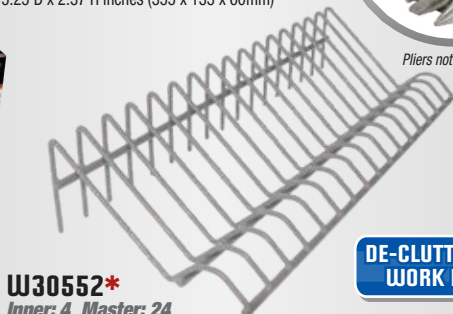

W30552*
Inner: 4 Master: 24

DE-CLUTTER YOUR WORK BENCH

12 SLOT WRENCH RACKS

- Rubberized polymer construction resists fuels and chemicals and has no sharp edges
- Non-slip slots lock in wrenches while still allowing easy one-handed removal
- Low profile fits shallow tool box drawers
- Fits multiple wrench sizes and styles
- Nail slots for mounting vertically

SAE W30591*
Inner: 5 Master: 30
Designed for SAE sizes wrenches: 1/4, 5/16, 3/8, 7/16, 1/2, 9/16, 5/8, 11/16, 3/4, 13/16, 7/8, 15/16 inch

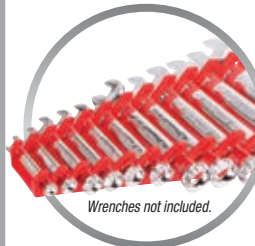

Wrenches not included.



METRIC W30592*
Inner: 5 Master: 30

Designed for metric sizes wrenches: 8, 9, 10, 11, 12, 13, 14, 15, 16, 17, 18 and 19mm

2 PK. 11-SLOT WRENCH RACKS

- Rubberized polymer construction resists fuels and chemicals and has no sharp edges
- Non-slip slots lock in wrenches while still allowing easy on-handed removal
- Full-size handle folds down to save space in toolbox drawer
- Low profile fits shallow tool box drawers
- Fits multiple wrench sizes and styles
- Nail slots for mounting vertically



PERFECT FOR YOUR WORKBENCH



W30595*
Inner: 10 Master: 60

12 BIN WALL MOUNT BIN SYSTEM

- Complete 12pc bin rack system for mounting to a wall or pegboard
- Comes with 6 mini bins, 6 small bins, 12.5 in. x 14.75 in. tall plastic mounting panel and hardware
- Bins will stack together for free standing storage or for transporting your parts to where they are needed
- Mini bins are 3.75" wide x 3.5 deep x 1.75 high with a 2 pound capacity
- Small bins are 4" wide x 6.5" deep and 2.75" high and have a 4 pound capacity



W530*
Inner: 1 Master: 1

PLASTIC PARTS ORGANIZER

- Durable injection molded plastic construction
- Full height internal dividers to keep parts separated
- Store flat or upright with built in feet



W5189*
Inner: 1 Master: 36

26 COMPARTMENT ORGANIZER

- Adjustable compartments for customizing
- Clear cover for quick identification
- Latch keeps compartments closed and secure
- Heavy duty built in handle for portable use
- Color labels



W54037*
Inner: 6 Master: 12

Contents not included.

15 BIN TABLE TOP STORAGE RACK

- Unique design provides plenty of storage below bins
- Use in home, office, garage or workshop
- Compact design fits anywhere
- Steel rack assembles in minutes



W5186*
Inner: 1 Master: 1

19" PLASTIC TOOL BOX

- Heavy-duty box with recessed ergonomic comfort handle
- Removable tray & lid organizers
- Strong double latch with padlock eyehole

REMOVABLE TRAY & LID ORGANIZERS



W54019*
Inner: 1 Master: 6

AMMO BOX - PLASTIC

- Heavy gauge polypropylene construction with reinforced lid
- Water resistant tongue-and groove lid
- Corrosion resistant bail latch
- Pre-drilled for padlock (lock sold separately)
- O.D. 11.5" wide, 5.25" deep and 7.2" Tall
- I.D. 9.5" wide, 4.25" deep and 6" tall

HEAVY DUTY



W5994*
Inner: 1 Master: 10

10 BIN WALL MOUNT STORAGE RACK

- For garage, home, office or garden
- Heavy duty metal bracket
- Mountable directly to wall studs
- Removable bins are convenient and easily accessible
- Includes 6 small bins and 4 large bins

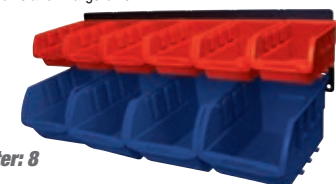

W5190*
Inner: 1 Master: 8

15 PC. STORAGE BIN SET

- Stack vertically or align horizontally
- Interlocking mounting rails
- Removable from rail



W5195*
Inner: 1 Master: 4

INTERLOCKING STORAGE BINS

- Interlocking bin design can be mounted vertically or horizontally - Stack multiple bins or combine with any of our other models.
- Transparent drawers for quick identification of drawer contents.
- Drawer catches prevent accidental drawer tip out.
- Wall mount notches on the back.
- Maximum Capacity: 40 Lbs. (18.2 Kg)



WALL MOUNTS NOTCHES

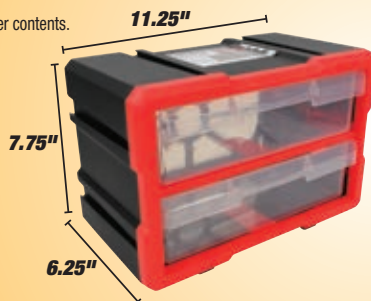

MIX & MATCH

4-DRAWER

W5911*
Inner: 1 Master: 6



12-DRAWER

W5912*
Inner: 1 Master: 6

2-DRAWER

W5910*
Inner: 1 Master: 6

*California Residents Prop 65 warnings see page 48.

SHOP EQUIPMENT

DIV HOOK AND LOOP STRAP KIT

- Designed to be cut to any length for any application
- With this kit you are able to make up to 30 straps
- 26 ft. (7.92 m) of hook & loop strapping with 30 buckles
- Designed for cable management and other organizational needs
- 0.8 in. (20 mm) wide strap material

W2949*
Inner: 1 Master: 60

NEW



2 PK. STORAGE STRAPS

- Heavy-duty storage straps made of 900 denier nylon material feature a spring-loaded carabiner gate for quick and secure storage.
- Total unfolded length of 16 in. (41 cm) and 1-1/2 in. (3.8 cm) wide, with 14 total inches of hook and loop fabric allows storage of items with a diameter of up to 5 in. (12.5 cm).

Sold in
INNER QTY.



W494*
Inner: 12 Master: 144

NEW

BX5 DUAL SAFETY UTILITY KNIFE

- 2-in-1 Safety Utility Knife - combines the safety of a self-retracting knife, with the strength of a retractable utility knife
- Dual action blade system allows you to operate in two modes
- Quick-change blade mechanism requires no tools to switch sides or blades
- Includes flip-top blade holder and 10 BX5 utility blades, made of high quality SK2 steel that lasts up to 5X longer than standard steel blades



W689*
Inner: 12 Master: 72

3-WHEEL MOVING DOLLY

- Soft cushions protect objects being moved
- Depressed center for objects with legs
- Holds up to 132lbs evenly distributed
- (3) 1-1/2" casters for easy maneuvering



W54038*
Inner: 6 Master: 36

50 PK. BX5 UTILITY KNIFE BLADES

- High quality SK2 steel lasts up to 5X longer than standard steel blades
- Easy to use blade dispenser. Fits standard utility knives
- Heavy duty blades precision honed to razor edge
- Indispensable around the home, shop & office



W7505*
Inner: 4 Master: 24

5 PK. BX5 UTILITY KNIFE BLADES

- High quality SK2 steel lasts up to 5X longer than standard steel blades
- Fits standard utility knives



W7503*
Inner: 24 Master: 144

1.88" X 55 YARDS PACKING TAPE

- High quality clear packing tape with high strength all weather adhesion
- Great for shipping, moving, storage, carton sealing
- 1.88 inches wide (50mm) x 54.6 yards (50 Meters)
- Use with Packing Tape Gun model 1518

1168*
Inner: 4 Master: 48



TAPE GUN W/ PACKING TAPE

- Must have item for moving, shipping packages or reorganizing
- Includes 2 inch W x 54 yards of clear packing tape
- Steel frame with high impact plastic handle
- Spring loaded tape brake



1518*
Inner: 4 Master: 24

TWO SHELF UTILITY CART W/DRAWER

- 2 Shelf cart with locking drawer
- Load Capacity: 350 Lbs
- Shelf dimensions 28" x 16" x 3 1/2" deep
- Drawer dimensions: 27" x 15" x 3 3/4" deep
- 2 swivel casters for easy maneuvering
- Overall height 35-1/4"



W54004*
Inner: 1 Master: 1

STEEL HAND TRUCK

- Heavy duty design, 18 gauge 1" steel tube frame
- Durable powder coated finish
- 10" 2-Ply pneumatic tires
- Extra large 14 x 7-1/2" toe plate
- 600 lbs. load capacity

W41060*
Inner: 1 Master: 1



UTILITY BLANKET 40" X 72"

- Non-woven polyester outer shell with a cotton/polyester fill for padding
- Double stitched non-woven fabric ensures your blanket will be durable enough for big moves and storage
- All ends are finished to keep blanket from unweaving or fraying for long life



W6044*
Inner: 1 Master: 8

POLY SERVICE CART 30 X 16"

- Easy Rolling Utility cart with upper and lower trays
- 2 shelf utility cart holds up to 500lbs total but is light weight and maneuverable
- Industrial duty polypropylene construction won't rust, dent or chip
- 5" Diameter non marring casters, (two locked and two swivel)
- Tool utility cart has tool storage and cup holder on the handle

W53991*
Inner: 1 Master: 1



HANDY PAPER TOWEL HOLDER

3 SHELF UTILITY CART W/DRAWER

- Four swivel casters, plus two locking casters
- Organizer shelf with bins
- Shelf with storage drawer
- Two 23 1/2" x 16" tool trays
- Foam drawer and tray liner
- Assembled Dimensions: 16 in. deep, 24 in. wide and stands 31 in. tall



W54006*
Inner: 1 Master: 1



25' 16GA RETRACTABLE CORD REEL

- Retractable cord reel for extended range
- 25ft 16GA cord with polarized plug and 3 grounded 10 amp outlets
- Durable steel housing
- Spring loaded auto-rewind
- Mounting brackets included
- UL listed E234282



W2272*
Inner: 1 Master: 4

CAN BE HUNG OR WALL MOUNTED

150' CAPACITY CORD REEL

- 11 inch diameter cord storage reel
- Heavy duty impact resistant housing
- Holds up to 150ft foot 16GA or 100 foot 12GA cord

Sold in MASTER QTY.

W2274*
Inner: 1 Master: 6



SHOP ESSENTIAL

Extension cord not included.

HOSE & CORD CARRY STRAP

- Holds extension cords, air hoses, water hoses or cables up to 3 inches in diameter
- Adjustable to two different sizes
- Easy to carry handle with built hang hole
- Great for easy carrying or organizing

W467*
Inner: 6 Master: 120

SHOP ESSENTIAL

Hose not included.



Sold in INNER QTY.

16" POWER TOOL STORAGE RACK

- This sturdy power tool organizer is wall mountable on the wall and provides ample storage for your tools
- The 3 levels of storage easily fit 4 power tools, chargers, batteries, and accessories
- Heavy 9-gauge steel frame, fully welded shelves, and 5mm thick wire will support up to 100-pounds of total storage
- 21-hole plate can be used to store screwdrivers or other accessories
- Rack measures: 15.7"W x 7.3"D x 8.4" tall

W7701*
Inner: 1 Master: 8

Tools not included.



ALUMINUM WORK PLATFORM

- Locking safety legs
- PVC ABS plastic non skid feet
- 19 1/2" high, 15 1/4" wide and 30" long
- Maximum weight capacity 225 lbs



225 lb.
LOAD CAPACITY

W54039*
Inner: 1 Master: 4

2-STEP FOLDING LADDER

- Heavy duty polystyrene is impact resistant and easy to clean for a long service life
- Ladder stands upright when folded up using minimal storage space
- Slip-resistant tread on steps and rubber non-skid foot pads
- Built-in handle and weighs under 10 pounds for easy transport
- Supports up to 300-pounds (136 kilograms)

W85040*
Inner: 1 Master: 4

Sold in MASTER QTY.



15" X-WIDE FOLDING STEP STOOL

- Extra-wide 15-inch platform for enhanced stability and safety
- Slip resistant rubber tread on platform and rubber foot pads for trouble free, non-skid performance
- Heavy-duty polystyrene is impact resistant and easy to clean for a long service life
- Compact design that easily folds up to save space and stores most anywhere
- Super strong load capacity supports up to 300 lb. (136 kg), evenly distributed

Sold in MASTER QTY.

COLLAPSIBLE FOR EASY STORAGE



W85041*
Inner: 1 Master: 8

LIGHTING

1000+LM LI-ION UNDERHOOD LIGHT

- Innovative design spans hoods over 6 feet wide and wraps up for compact storage
- 15-Inch flexible light bar provides a variety of uses and allows light to be directed right where you need it
- Powered by dual 18650 2200mAh Li-Ion batteries (included) and USB charging cable
- Specifications: 1071lm, 2.5hr runtime on high; 500lm, 4hr runtime on medium; 300lm, 5hr runtime on low

RUBBER PADDED HOOKS

STRETCHES OVER 6 FT. WIDE

WJ2673*
Inner: 1 Master: 20

2000LM LI-ION COMPACT FLASHLIGHT

- Uses professional grade lifetime Cree XPG LEDs
- IPX4 water resistance
- 4-Output Settings: Turbo beam 2000 lumen, High beam 1800 lumens, Medium beam 500 lumens, Low beam 100 lumens
- Powered by 3.7V 18350 800mAh Lithium-Ion battery with over discharge protection
- USB magnetic charge cable included

MAGNETIC CHARGER

2000+ LUMENS

WJ2679*
Inner: 8 Master: 48

550LM STRIP & SPOT HEADLAMP

- 550LM rechargeable COB strip and LED spot headlamp
- Uses professional grade licensed COB [Chip-on-Board] technology strip
- Adjustable strap with rear battery pack with power level indicator
- Powered by 3.7V 1800mAh Li-Polymer rechargeable battery (built-in)
- USB-C charge cord included (50 cm)

550 LUMENS

WJ2682*
Inner: 8 Master: 48

TILTING HEAD

5-Output Settings: COB + Spot 550 lumens, 2.5 hour run time. Spot 200 lumens, 5 hour run time. High COB 400 lumens, 4.5 hour run time. Low COB 200 lumens, 6.5 hour run time. Safe COB 23 lumens, 33 hour run time

500LM LOW PROFILE STRIP HEADLAMP

- 500LM rechargeable COB strip headlamp
- Uses professional grade licensed COB [Chip-on-Board] technology strips
- Adjustable strap with rear battery pack with power level indicator
- Powered by 3.7V 1800mAh Li-Polymer rechargeable battery (built-in)
- USB-C charge cord included (50 cm)

500 LUMENS

WJ2681*
Inner: 8 Master: 48

270° WIDE ANGLE LIGHT

4-Output Settings: High beam 500 lumens, 2.5 hour run time. Medium beam 250 lumens, 6 hour run time. Low beam 100 lumens, 10 hour run time. Safe Mode - 23 lumens, 33 hour run time

450+LM DUAL BEAM HEADLAMP

- Flexible silicone band and LED board provide over 200° of wide angle light, illuminating your peripheral vision
- Dual 21+ 1 LED light sources, each with high/low output
- 1200mah polymer rechargeable battery, with power indicator light, USB-C charging port and cable
- Comfortable, low profile and lightweight design features adjustable head band with reflective strip

450+ LUMENS

WJ2683*
Inner: 10 Master: 60

TOUCH-FREE ON/OFF

1500LM TRIPOD LI-ION WORK LIGHT

- Versatile work light produces over 1500 total lumens, and features folding tripod for use a handheld spotlight or free-standing
- Four output settings: full output spot and flood, single area light, dual area lights, focused spotlight
- Head pivots and rotates, allowing light to be directed where you need it
- Magnetic feet and swivel hook allow for hands-free operation
- Powered by two internal rechargeable 2200mAh 18650 lithium ion batteries, and doubles as a 4400mAh capacity power bank
- Includes USB-C charging cable

360° ROTATING BASE

CHARGE INDICATOR & HANG HOOK

DOUBLES AS POWER BANK

1500 LUMENS

MAGNETIC

TRIPOD BASE DOUBLES AS HANDLE

WJ2688*
Inner: 4 Master: 32

2000+LM LI-ION XL HEADLAMP

- Super bright Cree LED produces 2000+ lumens in boost mode.
- Features 3 output modes: turbo boost, high, and low.
- Flexible bracket allows light to be removed for use without the strap.
- Includes 2600mAh 18650 rechargeable lithium ion battery and micro USB charging cable (use replacement battery W2655B).

MAGNETIC FOR HANDS FREE

WJ2664*
Inner: 6 Master: 24

600+LM LI-ION 2-IN-1 HEADLAMP

- 4 functions: High 600 LM - 1.2 hr runtime - 295ft beam distance, Low 250 LM - 2 hr runtime - 180ft beam distance, Safe Mode - 65 LM - 4.75 hr runtime - 82ft beam distance, Strobe Mode - 3.5 hr runtime
- 3-4 hr charging time
- Magnetic USB charge cable included
- Powered by (1) 16340 3.7V lithium ion rechargeable battery (included)

600+ LUMENS

WJ2647*
Inner: 8 Master: 48

1000LM LI-ION UTILITY WORK LIGHT

- Versatile work light produces over 1000 lumens, and features spring loaded carabiner for clipping to belts, back packs, eyehooks, screws, nails, and more
- Pivoting carabiner hook and kickstand features magnet for multiple hands-free applications
- Powered by integrated rechargeable 1800mAh Li-poly battery, with battery level indicator LEDs, and 1m USB-C charging cable
- Built-in 1/4-20 in. threaded insert for use with tripods, camera mounts, and stands
- Specifications: 1060 lumens, 3 Hr. runtime on high; 300 lumens, 5.5 Hr. runtime on low

1000+ LUMENS

USB-C CHARGED

PIVOTS & DOUBLES AS KICKSTAND

WJ2689*
Inner: 4 Master: 24

1700LM LI-ION CLAMP WORK LIGHT

- Wide angle LEDs produce over 1700 lumens and distribute a large flood beam of light
- 360-degree rotating and pivoting clamp base assembly provides light in any direction and features rubber surface for positive grip
- Pivoting handle operates as a stand or for hanging/carrying
- USB charging port allows unit to function as a power bank - 5V @ 2A input/output power, battery indicator, (2) integrated 2200mAh 18650 li-ion batteries



360° ROTATING HEAD & PIVOTING CLAMP BASE



1700+ LUMENS

W2235*
Inner: 1 Master: 20

Specifications: 1720lm on high, 850lm on low, 4-hr runtime on high, 6-hr runtime on low; 5-6 hr charge time; 6500K CCT

300+LM 2-IN-1 LI-ION WORK LIGHT

- Area light and spotlight in one tool
- Comfortable lightweight housing with rubberized grip, pocket clip, and swivel hook
- Movable magnetic base for directing light in any direction
- Built-in rechargeable lithium ion 18650 battery with USB-C charging cable



300+ LUMENS



TILTING MAGNETIC BASE

2-IN-1 AREA & SPOT LIGHT

W2685*
Inner: 6 Master: 24

Specifications: area light: 332 lumens, 3 hr. run time; Spot light 117 lumens, 6 hr. run time. Charge time: ~2h, Input: 5V 1A, Battery: 3.7V DC, 1200mAh

1200+ LM LI-ION LED DROP LIGHT

- Built-in lithium ion batteries provide cordless operation for up to two hours
- Produces over 1200 lumens of bright white light
- Impact resistant handle with non-slip rubber grip and magnetic bracket
- Specifications: 1200 lumens, 2 hour runtime, 4 hour charging time, dual built-in 18650 2200mAh cells, 3.7V, 3.6A, 0.9A input current
- Includes 1M (39 inch) micro USB charging cable
- US Patent D883560

W2240*
Inner: 4 Master: 16

1200+ LUMENS



1200+LM LI-ION WORK LIGHT

- Produces over 1200 lumens of bright white light
- Pivoting handle can be used as a stand or hanging/carrying and includes a snap-on hook
- Specs: 1206 lumens on high, 606 lumens on low, 2 hour runtime on high, 4 hour runtime on low
- Battery indicator and 5V @ 2A input/output power, 4400mAh li-ion batteries, 3-4 hour charge time

W2234*
Inner: 6 Master: 24



1200+ LUMENS

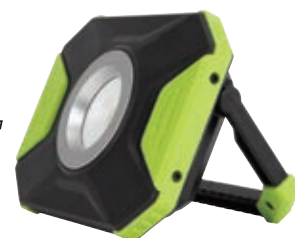

150+LM LI-ION THIN WORK LIGHT

- Double hinged light bar provides 360 degrees of light for precise illumination
- Compact design with thin, low profile light bar for access in confined areas
- Features additional light at the tip, magnetic base, swivel hook and pocket clip
- Integrated 14500 lithium-ion rechargeable battery (USB cord included)

BULK 20244*
Inner: 6 Master: 144



150+ LUMENS

CARDED W2646*
Inner: 12 Master: 72

300+LM LI-ION COMPACT WORK LIGHT

- Features high output wide angle LEDs for a flood of light
- Rare earth magnet on back for hands free work
- Flip-up hook for added versatility
- Built-in rechargeable lithium ion battery
- includes micro USB charging cable

Sold in INNER QTY.



W2675*
Inner: 8 Master: 96

Specifications: 320 Lumens, 3 hr run time, 1000mAh, 3.7V ; Dimensions: 3 x 1.75 x 0.8" (75 x 44 x 20mm)

650+LM LI-ION FOLDING SLIM WORK LIGHT

- Variable output dial adjust lights from 150 to almost 700 lumens
- Slim, double jointed light bar provides 360° of light, rotates 270°, and is great for confined areas
- Swivel hook and removable 360° swivel magnetic base for hands free use
- Built-in 2200mAh rechargeable lithium-ion 18650 battery and charging cable
- Specifications: 690 lumens on high, 2.25 hour, run time (high), 5 hour run time (low); Charge time: ~2 hour, Input: 5V 1A, Battery: 3.7V DC, 2200mAh, USB cable length: 80cm



650+ LUMENS

PROVIDES 360° OF LIGHT

MAGNETIC BASE

W2232*
Inner: 6 Master: 48



600+LM LI-ION SLIM WORK LIGHT

- Variable output dial adjust light output from 150 to over 600 lumens
- Thin, low profile light bar body for access in confined areas
- Swivel hook and removable 360° swivel magnetic base for hands free use
- Built-in rechargeable lithium ion 18650 battery and charging cable

600+ LUMENS

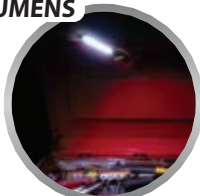

W2231*
Inner: 10 Master: 50

MAGNETIC BASE



500+LM LI-ION 3-IN-1 WORK LIGHT

- Multiple output settings: flashlight; focused spot light, area light, combined spot/area light provides from 130 to 500+ lumens
- Spot light features warm white for a more natural light and better color recognition
- Magnetic swivel base for hands free use and positioning light where you need it
- Pocket clip with swivel hook for added utility
- Specifications: 337lm spot light, 341lm area light, 561lm combined, 138lm flashlight, Run time 2.5h (max), 7h (min); Charge time: 2.5h, Battery: 3.7V DC, 1500mAh



500+ LUMENS

TILTING MAGNETIC BASE

W2325*
Inner: 6 Master: 48



*California Residents Prop 65 warnings see page 48.

LIGHTING



4000+LM FIREPOINT X LI-ION FLASHLIGHT

- Adjustable DuoFocus beam goes from spot to flood.
- Water and impact resistant.
- Includes USB battery charger and (2) 26650 Li-ion batteries: 3.7V, 3400mAh capacity, 12.58 watt hours.
- Specifications: 4026 lumens on high, 480 lumens on low, 4.5 hour runtime on high, 12.5 hour runtime on low, beam distance: 320m (high), 130m (low), 215mm total length

W2669*
Inner: 6 Master: 24



3000+LM FIREPOINT X LI-ION FLASHLIGHT

- Adjustable DuoFocus beam goes from spot to flood.
- Water and impact resistant.
- Specifications: 3061 lumens on high, 754 lumens on low, 3 hour runtime on high, 6 hour runtime on low, 16000cd, 253m beam, 208mm total length.
- Includes (2) 2600mAh, 3.7V Li-ion batteries.
- Includes USB battery charger

W2655*
Inner: 6 Master: 24



1000+LM FIREPOINT X LI-ION FLASHLIGHT

- Adjustable DuoFocus beam goes from spot to flood.
- Water and impact resistant.
- Specifications: 1001 lumens on high, 227 lumens on low, 4 hour runtime on high, 6 hour runtime on low, 175mm total length.
- Requires (1) 18650 Li-ion battery (included) or 3AAA batteries (not included)

W2658*
Inner: 6 Master: 24



300+LM FIREPOINT X LI-ION FLASHLIGHT

- Adjustable DuoFocus beam goes from spot to flood.
- Water and impact resistant.
- Specifications: 316 lumens on high, 100 lumens on low, 0.5 hour runtime on high, 1.5 hour runtime on low, beam distance: 125m (high), 69m (low).
- Built-in 10440, 320mAh capacity, li-ion battery (included)

DISPLAY W2661*
Inner: 8 Master: 32

Sold in INNER QTY.



CARDED W2663*
Inner: 6 Master: 24



350+LM FIREPOINT X LI-ION DUO-LIGHT

- Duo-light features flashlight with side-emitting work light for a wide flood beam of light.
- Adjustable DuoFocus beam goes from spot to flood.
- Specifications: flashlight - 196 lumens on high 2.5hr runtime; work light: 375 lumens, 1.5hr runtime (high); 100lm, 4hr (low).
- Built-in 14500, 600mAh capacity, li-ion battery (included)

W2672*
Inner: 8 Master: 32



350+ LUMENS

Sold in INNER QTY.

2-IN-1 WORK LIGHT/ FLASHLIGHT



300+LM FIREPOINT X PENLIGHT

- Adjustable DuoFocus beam goes from spot to flood
- Super bright LED never needs replacing
- Anodized tactical aluminum housing with pocket clip
- Water and impact resistant
- Specifications: 303 lumens on high, 65 lumens on low, 1 hour runtime on high, 2 hour runtime on low, 133mm total length
- Requires 2AAA batteries (included)

W2680*
Inner: 8 Master: 32



Sold in INNER QTY.

300+ LUMENS



700+LM CLEAR VIEW LI-ION LED WORK LIGHT

- Folding neck and clear view handle provide a compact light, or a slim area light or spotlight for confined areas
- Impact resistant handle with comfortable rubber grip, hook, and magnetic base for hands free use
- Produces over 700 lumens of bright white light
- Slim, low profile light bar pivots 180° for precise illumination in confined areas
- 2000mAh battery and USB-C charging cable included

W2684*
Inner: 6 Master: 24



500+LM FOLDING THIN WORK LIGHT

- High output area light and spotlight in one tool
- Magnetic base for hands free use
- Produces over 500 lumens of bright white light
- Light bar adjusts 120° for precise illumination
- Thin, low profile light bar body for access in confined areas
- Impact resistant handle with comfortable rubber grip

500+ LUMENS



W2418*
Inner: 5 Master: 20

200+LM LED PENLIGHT

- High output LEDs produce over 200 lumens.
- Comfortable lightweight housing with textured grip.
- Magnetic back and pocket clip for hands free use.
- Includes 3AAA batteries.
- Specifications: 221 lumens, 2 hr. runtime on high, 67 lumens, 15 hr. runtime on low.

W2319*
Inner: 12 Master: 48

MAGNETIC POCKET CLIP

NEW



Sold in INNER QTY.



3 PK. 65LM STORM COMPOSITE FLASHLIGHTS

- Super Bright LEDs never needs replacing
- Flashlight submersible to one meter
- 65 lumens, 6.5 hour runtime, 1459cd, 76m beam
- 9AAA batteries included
- US Patent D659870



W2494*
Inner: 6 Master: 24

3000+ LM 120V LED WORK LIGHT

- Wide angle LEDs produce over 3000 lumens and distribute a large flood beam of light
- 360-degree rotating head and pivoting base assembly provides light in any direction
- Features integrated swivel hook and nail slots for surface mounting
- LED technology means unit stays cool enough to touch
- ETL listed 5020004

360° ROTATING HEAD & PIVOTING BASE



3000+ LUMENS



120Volt

W2233*
Inner: 1 Master: 20

3 PK. LED SAFETY ROAD FLARES W/BAG

- Make others aware of your vehicle even if the vehicle battery is dead.
- Tough plastic construction is compact and lightweight.
- 12 bright red LEDs last up to 50 hours.
- Swivel hook and magnet on back for hands free use.
- Includes handy mesh storage bag



W2383*
Inner: 6 Master: 24



STORAGE BAG



EMERGENCY ESSENTIAL

1000+LM 120V LED DROP LIGHT

- All the durability of a traditional drop light with the efficiency of LED technology.
- Produces over 1000 lumens of bright white light.
- Impact resistant handle with non-slip rubber grip.
- Powder coated metal lamp shield with swivel hang hook.
- 25ft grounded cord with built-in 120V outlet (500W MAX).
- US Patent D883560

W2237*
Inner: 4 Master: 16



120V STEEL CAGE PRO DROP LIGHT

- Reflective galvanized metal lamp shield with swivel hang hook
- Impact resistant handle with comfortable non-slip rubber grip
- Standard E26 light socket uses up to 75 watt incandescent bulb or LED equivalent
- 25ft grounded cord with built-in 120V outlet (500W MAX)
- US Patent D883560

W2243*
Inner: 4 Master: 16
Designed for use with LED A19/A26 style bulbs, Performance Tool Models W2282/W2283



25' 16GA BLUE EXTENSION CORD

- All-weather indoor/outdoor extension cord features lighted outlet that readily indicates power available
- High visibility blue coating resists moisture, abrasion, and UV sunlight
- Cold weather resistant materials are temperature rated to 4° F (-20° C)
- cETL listed 3126867

50 FT. W2257*
Inner: 1 Master: 12

25 FT. W2256*
Inner: 1 Master: 18



LIGHTED END



HANDY HANG HOLE

120VOLT

1000LM 120V WORKBENCH POWER STATION

- This versatile power station is commercial grade with lighted on/off switches and built in circuit breaker, instantly adds 120v electrical outlets, USB ports and additional lighting to your work space
- 6 commercial quality outlets are copper coated with riveted construction
- 2 LED lights pivot up to 90 degrees and put out a total of 1000 lumens of 6000K daylight
- 2 USB charging ports provide 5v@2.4 amp on each (3.4A total max) with over current protection
- 6 ft. 14/3 AWG with heavy rubber coating and grounded 3 prong plug
- cULus listed: E511046

W2279*
Inner: 1 Master: 4

1000+ LUMENS



BUILT-IN CELL PHONE CRADLE

LED CEILING LIGHT (ONLY)

W2284*
Inner: 1 Master: 18



TRI-WING FOLDABLE DESIGN

Specifications: input voltage AC85-265V 50-60Hz; CRI 80Ra; 3000K color temperature

ROUGH SERVICE LED LIGHT BULB

- Energy efficient replacement to standard incandescent or CFL light bulbs
- Fits most standard E26 type sockets
- Specifications: input voltage 110-250V AC; CRI 80Ra; 2700K color temperature; 50-60Hz; minimum lifetime of 3600 hours
- Instant on, no warm up time and dimmable

1200LM W2282*
Inner: 10 Master: 50

ROUGH SERVICE

1500LM W2283*
Inner: 10 Master: 50



6500+LM 120V WORK LIGHT W/TRIPOD

- Includes 120V E26 threaded ceiling light, 120V adapter with 12ft cord, and 3-section telescoping tripod stand
- Energy efficient replacement to high output halogen, halide, sodium or other incandescent lights
- Uses the same energy as a 60W incandescent light bulb, but produces nearly 8 times the amount of light
- Instant on, no warm up time and dimmable with die cast cooling blades to dissipate heat and provide optimal output

W2286*
Inner: 1 Master: 4

6500+ LUMENS



FULLY ADJUSTABLE 27-1/2 TO 78-1/2 IN.



BATTERY SERVICE

BATTERY JUMPER CABLES

- Red/black PVC-coated insulated clamps for easy identification
- Tangle-free rubber coated cables
- Operating temperature range: -13 to 158 degrees F (-25 to 70 degrees C)



2GA 20 FT.

- Commercial duty for tractors, semis, buses, and RVs
- 2 Gauge, 20 Foot, 600 AMP/800 Peak

W1669*

Inner: 1 Master: 4



4GA 20 FT. COPPER

- Heavy duty for full size trucks, vans and SUVs
- Heavy duty copper jaw clamps
- 4 Gauge, 20 Foot, 500 AMP/600 AMP Peak
- 100% Copper Cable

W1667*

Inner: 1 Master: 6



4GA 20 FT.

- Heavy duty for full size trucks, vans and SUVs
- Heavy duty copper jaw clamps
- 4 Gauge, 20 Foot, 500 AMP/600 Peak

W1673*

Inner: 1 Master: 6



6GA 16 FT.

- Standard duty for large cars and mid-size pick-up trucks and SUVs
- Heavy duty copper jaw clamps
- 6 Gauge, 16 Foot, 400 AMP/500 Peak

W1672*

Inner: 1 Master: 6



4GA 10' LIGHTED BATTERY JUMPER CABLES

- Clamps feature integrated LEDs to illuminate your working area at night or in a dark garage
- Red/black non-conductive clamps for easy polarity identification with tangle-free rubber coated cables
- Standard duty for large cars and mid-size pick-up trucks and SUVs
- 4 Gauge, 10 Foot, 220 AMP/400 Peak



LED



W1675*

Inner: 1 Master: 6

900 AMP JUMP STARTER WITH INFLATOR

- 900 Peak Amps/400 Cranking Amp Jump Starter
- 300 psi Air Compressor/Inflator for pumping up tires and more
- Reverse polarity warning light and beep signal help prevent damaging unit or battery
- Two 12V Power Adapter Outlets
- Equipped with 12 Volt, 12AH Sealed Lead Acid Battery
- One UL Certified 120V/12V charging adapter

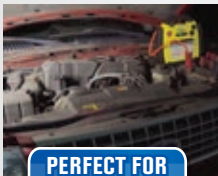

PERFECT FOR EMERGENCIES

W1665*

Inner: 1 Master: 2

6GA 16' BATTERY JUMPER CABLES

- Heavy duty for full size trucks, vans and SUVs.
- Red/black PVC-coated alligator clamps for easy identification.
- Jaws are designed for both side post and top post batteries.
- 6 Gauge, 16 foot, 400 AMP/500 AMP peak.
- All weather use.
- 100% Copper cable provides unparalleled conductivity.
- Operating temperature range: -50.8 to 158 degrees F (-46 to 75 degrees C)

**100%
COPPER CABLES**

NEW

W1668*

Inner: 1 Master: 6



8GA 12 FT.

- Medium duty for passenger light cars & pick-up trucks
- Heavy duty copper jaw clamps
- 8 Gauge, 12 Foot, 250 AMP/300 Peak

W1671*

Inner: 6 Master: 12



10GA 12 FT.

- Light duty for compact vehicles & motorcycles
- Heavy duty copper jaw clamps
- 10 Gauge, 12 Foot, 150 AMP/250 Peak

W1670*

Inner: 6 Master: 12



DIGITAL AUTOMOTIVE MULTIMETER

- Perform all standard tests for on the car or bench troubleshooting
- Safely troubleshoot a variety of automotive, household and shop electrical circuits
- Test electrical components for faulty wiring and voltage
- Verify voltage on engine sensors, ignition, fuel systems and charging systems
- Test Leads are 42" or 3.5' Long
- Use F0.5AL250V 5X20mm Fuse



W2969*

Inner: 6 Master: 36

DIGITAL AUTOMOTIVE MULTIMETER

- Performs all standard automotive electrical tests on the car or bench troubleshooting
- Measure and set typical automotive functions with the tach and dwell setting
- Test electrical components for faulty wiring and voltage
- Check starting, charging and fuel delivery system voltage, and diode function
- Test Leads are 42" or 3.5' Long
- Use F0.5AL250V 5X20mm Fuse



WITH DWELL SETTINGS

W2972*

Inner: 6 Master: 36

100 AMP BATTERY LOAD TESTER

- Accurately test the condition of your battery and charging systems
- Performs both a voltage test and 15-second battery-load test. 100-amp capacity
- Reliable and highly accurate, works on both 6- and 12-volt batteries
- Extra heavy leads with strain relief and color-coded, insulated, copper plated steel clamps



W2988*
Inner: 1 Master: 10

RELIABLE & ACCURATE

DELUXE BATTERY TESTER

- Test 6V, 12V and 24V batteries
- Dial indicator style
- Instant reading warm or cold

W1657C*
Inner: 6 Master: 72



BATTERY TESTER

- Color coded balls for easy readings

W1666C*
Inner: 24 Master: 288



2-IN-1 DRAIN PAN TOOL CADDY

- Oil drain pan and mobile tool caddy, two tools in one
- Use together when changing oil, or separately keeping your tools organized while under the car
- Unique splash guard and oil filter drain post on an 8 liter drain pan, perfect for any shop
- Oil drain pan is designed to cradles into the tool caddy making the pan mobile, easy to position



ROLLS TO WHERE YOU NEED IT



TOOL CADDY



DRAIN PAN

Tools not included.

W4074*
Inner: 1 Master: 1

CLEAR VIEW 7 QT. PLASTIC DRAIN PAN

- Transparent polypropylene constructions allows quick and easy monitoring of liquid
- Molded handles and pour spout are easy to use
- Chemical and solvent resistant, won't rust or corrode
- Dimensions: 13-1/2 x 11 x 4 in. (343x 279 x 102 mm)
- Approximate capacity: 7 quarts, 1.75 gallons, 6.6 liters

W4068*
Inner: 1 Master: 12

EASY TO USE POUR SPOUT

CONVENIENT HANG HOLE



3 PC. ELECTRICIAN TOOL SET

- Digital Multi meter measures AC and DC voltage, tests DC current and resistance, diode test and features a digital display and data storage
- 7 in. diagonal wire cutting pliers feature short jaws for easy cutting in tight areas, drop-forged and induction-hardened for durability
- 7 in. wire stripper/cutter for 10-20 AWG wire, cuts and threads popular bolt sizes, wire looping/bending holes, and serrated nose



W1714*
Inner: 6 Master: 24

PRO ANTI-FREEZE TESTER

- Precision calibrated
- Color coded indicator float
- Acid resistant

W1654C*
Inner: 6 Master: 72



ANTI-FREEZE TESTER

- Color coded balls for easy readings

W1655C*
Inner: 24 Master: 288



DELUXE ANTI-FREEZE TESTER

- Easy to read scale & pointer
- Freezing to boiling points for anti-freeze, calibrated in C and F

W1656C*
Inner: 6 Master: 72



4-IN-1 OIL FILTER WRENCH

- Swivel handle and four interchangeable bands, great for anyone who does regular oil filter changes
- Wide dimpled bands prevent crushing and keep a tight grip on a wide range of oil filters
- The bands are easily interchanged by removing and installing two detent retention pins
- 1 in. wide bands are constructed of high-carbon steel and are coated for additional corrosion protection
- Features a vinyl grip handle, 180 deg. swivel joint and four interchangeable steel bands

FITS FILTERS FROM 2-3/8 TO 4-3/8 IN.



W54132*
Inner: 6 Master: 36

FLEXIBLE FUNNEL SPOUT

- Easily add oil, coolant, or window cleaner from a gallon jug to any vehicle without mess or spills
- The double-threaded cap fits both gallon-size containers, standard (37mm) and wide mouth (50mm)
- Uniquely designed air bleed-off valve for faster and smoother fluid flow, up to five times faster
- A special rotary on-off switch helps effectively control the flow providing a positive shut-off
- The accordion-style spout is moldable and will hold its shape allowing for easier and more exact pours
- Patent Pending

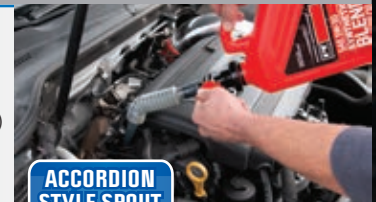

ACCORDION STYLE SPOUT



FITS BOTH WIDE (50MM) & STANDARD MOUTH (37MM)

W4060*
Inner: 6 Master: 36



OIL CHANGE

ABSORBENT FLOOR MATS

- Made of high quality felt with hot-melt adhesive backing to reduce moisture seepage and slipping.
- Helps reduce the spreading of dirt, grease, or any mess.
- Easily cut to fit any desired shape and place with double sided tape (included).
- Simply clean with vacuum and/or water with mild detergent if needed.
- Hang dry only, do not use harsh chemicals or bleach when cleaning



NEW

KEEP YOUR SHOP OR GARAGE CLEAN FROM SPILLS

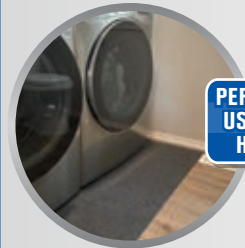

PERFECT FOR MANY USES AROUND THE HOUSE OR SHOP

EASILY CUT TO ANY SHAPE

1.5 mm THICK

9 FT. X 2.4 FT. W88801*

Inner: 1 Master: 20

18 FT. X 2.4 FT. W88802*

Inner: 1 Master: 10

20 FT. X 7.4 FT. W88803*

Inner: 1 Master: 4

11 QUART OIL DRAIN PAN

- Rectangular shape is designed to better collect oil and prevents messy spills without having to move the pan around.
- High-capacity volume is large enough to hold up to two oil changes or 11 quarts of oil (10 L) or a complete radiator flush.
- Made from durable, chemical-resistant plastic, this oil drain pan is built to last and perfect for your garage.
- Convenient integrated oil filter stand allows you to drain the excess oil in filter without getting it messy.
- All-around hand grips provide easy carrying, maneuvering, and pouring through a recessed corner spout.
- Dimensions: 22.4 x 12.6 x 4.1 in. (570 x 320 x 105 mm)

NEW

CONVENIENT OIL FILTER STAND



W4079*

Inner: 1 Master: 10

OIL DRAIN CONTAINERS

- Heavy wall construction keeps container rigid, even when draining hot engine oil.
- Integrated handles for convenient carrying, pouring, and transport to recycling center.
- Deep drain well with angled sides minimize splashing and spilling during oil draining.
- High quality tethered plastic caps with rubber gaskets for a leak free seal.
- Made from durable polypropylene material.

DEEP DRAIN WELL

Angled sides minimize splashing and spilling

NEW

LARGER VENTING HOLE

5/8 in. opening, over 300% larger than competition



UNIQUE 2-IN-1 DESIGN ESSENTIAL FOR EVERY DIY MECHANIC

INTEGRATED HANDLE

For convenient carrying, pouring, and transport

HEAVY WALL CONSTRUCTION

Keeps container rigid, even when draining hot oil

TETHERED PLASTIC CAPS

With rubber gaskets for a leak free seal



VIDEO LINK

3 DIFFERENT SIZES TO FIT YOUR NEEDS



10 QUART

W4076*

Inner: 1 Master: 6

10
Quart
Litre
Cuarto



16 QUART

W4077*

Inner: 1 Master: 4

16
Quart
Litre
Cuarto



24 QUART

W4078*

Inner: 1 Master: 2

24
Quart
Litre
Cuarto

CLEAR FUNNEL Program

VIEW

HANDY HANG HOLE

For convenient storage

TRANSPARENT DESIGN

For easy monitoring of liquid

INTEGRATED SPLASH GUARDS



CLEAR VIEW EASY-FILL FUNNEL 1 GALLON

- Contoured designed provides an easy-to-carry handle for holding and positioning
- Vented nozzle and wide opening enable filling at a high velocity
- Mesh filter prevents larger contaminants from entering your tank, radiator, or engine
- Approximate capacity: 3500ml, 3.7 Quarts, 0.92 gallons, 118.3 ounces



W4051*

Inner: 1 Master: 72

CLEAR VIEW EASY-FILL FUNNEL 1 QUART

- Large bowl area is designed to accommodate larger fluid bottles
- Oversized spout increases flow and fill rate
- Splash guard directs fluid where you want it, and reduces spillage
- Approximate capacity: 800ml, 1.7 Pints, 27 ounces



W4057*

Inner: 1 Master: 48

CLEAR VIEW EASY HOLD FUNNEL 2 PINT

- Unique design holds standard quart sized oil bottles while they drain allowing hands-free operation
- Spout features concentric ridges that secure the funnel in your engine's filler hole
- Accommodates nearly all shapes and sizes of 1-quart oil bottles
- Approximate capacity: 800ml, 1.7 Pints, 27 Ounces



W4055*

Inner: 1 Master: 64

CLEAR VIEW LONG REACH FUNNEL 1 PINT

- Upgraded design features thicker construction, extended vent channels, and positive handholds
- Splash resistant guard and extended length provide quicker, cleaner transfer of liquid
- Approximate capacity: 500ml, 1.1 pints, 16.9 ounces



W4052*

Inner: 1 Master: 144

CLEAR VIEW LONG REACH FUNNEL 1/2 PINT

- Great multi-purpose funnel for every day needs such as oil, coolant, gasoline, transmission fluid and more
- Splash guard directs fluid where you want it, and reduces spillage
- Approximate capacity: 200ml, 0.4 Pints, 6.8 Ounces



W4054*

Inner: 1 Master: 168

CLEAR VIEW EASY-FILL FUNNEL 1/2 PINT

- Specifically designed with a shallow spout for use with radiators, but can also be used for oil, gas, and other fluids
- Notched lip works as a bottle rest for easier pouring
- Wide mouth openings for quick, high velocity pouring
- Approximate capacity: 200ml, 0.4 Pints, 6.8 Ounces



W4056*
Inner: 1 Master: 144

3 PC. CLEAR VIEW EASY-FILL FUNNEL

- Features three distinct funnels for all your liquid filling needs: multi-purpose long reach funnel, Easy-Fill radiator funnel, and Jr. Jumbo Easy-Fill
- Having a different funnel for each liquid helps prevent cross contamination
- Integrated hang holes for convenient storage
- Approximate capacities: 200, 300, 800ml; 0.4, 0.6, 1.7 Pints; 6.8, 10.1, 27 ounces



W4053*
Inner: 1 Master: 24

*California Residents
Prop 65 warnings see page 48.

5 GALLON OIL LIFT DRAIN

- Telescopic tube adjusts to desired height
- Range 40 1/2" to 60" with 13-1/2" diameter funnel
- Comes complete with heavy duty 5 gallon container
- Telescopic tube and sturdy funnel

W54282*
Inner: 1 Master: 1



ROLLING BASE FOR LIFT DRAIN

- Heavy duty steel construction
- Baked enamel finish
- Ball bearing type casters
- For use with Performance Tool part #W54282

W54283*
Inner: 1 Master: 4



LOCK-ON GREASE COUPLER

- Allows you to lock on the fitting with just a slight push, releases with the same minimal effort
- Fits most grease guns and accessories
- Positive seal prevents leakage while pumping grease up to 10,000psi
- Once locked on both hands can be used to operate the grease gun

W54228*
Inner: 10 Master: 100



5-1/2" CURVED GREASE PIPE

- Use with most hand-operated grease gun couplers
- Used for applications such as lubricating motor vehicles, construction and industrial equipment
- Plated for Maximum Protection against corrosion
- Fits all 1/8" NPT thread grease accessories. 6,000 psi operating pressure

W54297*
Inner: 6 Master: 144



CURVED FOR HARD TO REACH AREAS

BATTERY OPERATED TRANSFER PUMP

- This highly versatile battery operated pump is capable of 2.6 gallons per minute
- Pump fuel from your safety can to a generator, car, motorcycle, lawn equipment or any other fuel driven item. Works well with kerosene for heaters or stoves also
- Chemical fluids, cleaners, water (not for use with drinking water), light oil, etc



W54172*
Inner: 6 Master: 24

200CC EXTRACTION & FILL PUMP

- Semi translucent cylinder for viewing exact fluid volume and overall fluid condition
- Unique hose coupler offers a positive hose connection, but still easy to remove
- The body of the cylinder is calibrated with both English & Metric measurements
- Includes two 7-1/2 in. hoses; one 5/16 in. and one 1/4 in. with a coupler to join them together



W54173*
Inner: 12 Master: 24

20V CORDLESS HIGH VOLUME GREASE GUN

- 20V Motor and high-volume pump deliver up to 10 oz. per minute and a maximum pressure of 10,000 PSI
- A total of five adjustment levels allow you the control of using maximum pressure when dealing with clogged/jammed fittings or maximum flow rate for high-volume applications
- Die-cast aluminum head with built-in air bleeder valve assists in quick priming after refills to get you back on the job fast
- Heavy gauge steel barrel with easy-grip knurling will hold up to 14.5 oz. of grease using either cartridge, suction, or bulk loading
- Pressure release valve is preset at 10,000 PSI to prevent excessive pressure build-up and avoid gear/ motor damage
- The 20V 2.0Ah lithium-ion battery will dispense up to 10 cartridges of multi-purpose grease per charge
- 4-jaw coupler, 20V 2.0Ah Li-ion battery, charger, and shoulder strap

W7721*
Inner: 1 Master: 2

PRESSURE RELEASE VALVE

VARIABLE SPEED

48 IN. NO KINK HOSE

LED

SHOULDER STRAP INCLUDED



HIGH VOLUME LEVER ACTION GREASE GUN

- Three times the grease output per stroke reduces application time by one third
- Durable cast iron pump head, dual piston design provides high volume long lasting performance
- A dual grease inlet ensures no loss of prime even in extreme cold weather
- Rigid delivery tube and heavy duty push-on hydraulic 4-jaw coupler
- Develops up to 10,000 psi to deliver 1 oz of grease per 7 strokes

W54296*
Inner: 1 Master: 12



ALUMINUM BUNG WRENCH

- Used to remove 2 in. and 3/4 in. bung caps on most 15, 30, and 55 gallon drums
- The offset handle design works well on recessed countersunk bung caps
- The wrench used in agriculture, construction, industrial, vehicle, and fleet service applications
- Universal, fits most metal or plastic water, diesel, chemical, oil, and fuel drums caps
- Made of non-sparking cast aluminum, ensuring no chance for spark accidents
- For metal or plastic caps/bungs, size 2 in., 3/4 in., length 10-5/16 in., lightweight 6.3 ounces (0.18kg.)



OFFSET HANDLE

UNIVERSAL SIZE

W54160*
Inner: 1 Master: 40



CLEAR VIEW LEVER ACTION GREASE GUN

- Unique window cut-outs for better identification of grease types
- Variable stroke enables the operator to work in tight and narrow spaces
- Built-in air pocket release valve for convenient release of trapped air
- Eliminate cross contamination from adding the incorrect grease to equipment
- Working pressure: 3000 psi. Develops 5000 psi
- Delivers: 1 oz. / 40 strokes. Capacity: 14 oz. / 400 c.c

CLEAR VIEW

W54293*
Inner: 1 Master: 12



WHEEL DOLLY (1 PAIR)

- Move your car, riding mower, trailer and much more in any direction with just a push
- Makes storage and service and restoration easier
- 1,000 lb capacity per dolly
- 3 1/2" cast iron swivel ball bearing casters
- Accepts tires up to 14" wide
- Overall size: 23 1/2" x 15 1/2" x 5 1/2"
- makes storages service and restoration easier



WJ54013*
Inner: 1 Master: 1

18" SOLID WOOD TIRE THUMPER - 10 OZ.

- Our 10 oz. (283 g) tire thumper is the most convenient and effective way to quickly check for tire pressure to help you stay safe on the road.
- 18 in. (45.7 cm) Stained hardwood construction is durable and long-lasting.
- Nylon wrist strap for carrying the tire thumper or hanging it for easy access.
- Slotted handle design improves comfort and provides excellent grip when in use.
- Dimension: 18 in. (45.7 cm) long x 1-1/2 in. (3.8 cm) in diameter; Weight: 10 oz. (283 g)



WJ3069*
Inner: 1 Master: 40

NEW

SLOTTED HANDLE

HANDY WRIST LANYARD

11 PC. MASTER LUG NUT SOCKET SET

- Complete assortment of emergency lug nut removal sockets ensure you always have the right size
- Designed to fit lug nuts that measure 17, 18.5, 20, 21.5, 23, 24.5 or 26mm and 3/4, 13/16, 1 and 1-1/8 inch, diameter, or corner to corner
- Heavy duty impact-grade CrMo steel will not split or crack
- Oil resistant black phosphate finish



M991*
Inner: 1 Master: 12

EMERGENCY LUG NUT REMOVAL SET

- Can remove lug nuts & locking lug nuts, if the lug nut key is misplaced, lost or lug nuts are worn, stripped or damaged
- Heavy duty impact-grade steel will not split or crack
- 13/16" and 1" sizes fit most lug nuts/ bolts on most vehicles



M980*
Inner: 6 Master: 72

LOCKING LUG NUT MASTER KEY SET

- 16 different key shapes to fit a wide variety of stock and after-market wheel locking lug nuts
- Double hex-head design allows them to be used with both 13/16 and 7/8 in. lug or combo wrench
- Thin walls and extra-long helps protect the wheel during use to prevent nicks and scratches
- Includes Spline Style Keys: 5-spline, 6-spline, 7-spline, and 12-spline. Hex Keys: 9/16-inch, 12mm, 12mm fluted, and 15mm. Star Keys: 8-point, 9-point, 10-point



M994*
Inner: 1 Master: 5

5 GALLON TIRE BEAD SEATER

- 5 Gallon Tire Bead Seater Inflator
- Heavy duty ball valve on both air inlet and exhaust port
- Designed to seat tires on the bead of wheel simply, safe, and fast
- Works on tires up to 24.5 inches

WJ10012*
Inner: 1 Master: 1



SAE/METRIC BREAKDOWN LUG WRENCH

- Full size lug wrench breaks down into two parts for compact storage.
- Two position center rod allows for applying added torque to those really tight lug nuts.
- Includes 11/16 + 3/4 inch, 13/16 + 15/16 inch, 17 mm + 19 mm, and 21 mm + 23 mm double ended sockets.
- Nylon storage pouch to keep everything together.
- Free spinning handle with push button release.

WJ8*
Inner: 2 Master: 8



24" TIRE SPOON

- Use to mount or demount passenger car, motorcycle, ATV, and light truck tires
- Curved spoon end, for better leverage between the tire and the wheel to easily separate tire beads
- Designed for fast and efficient tire changing, manually or with a tire machine
- Rugged forged steel construction with a plated finish
- Length 24 in., Size 11/16 in. Stock

CURVED FOR BETTER LEVERAGE



WJ17*
Inner: 10 Master: 20

AIR TANKS

- 125 PSI maximum
- Light weight, portable with handle for easy transport
- Safety pressure bypass valve with manual override
- Industrial grade air hose with standard tire air chuck
- Parts Available Separately: Hose W10057, Manifold W10056, Gauge W10055

11 GALLON

WJ10011*
Inner: 1 Master: 1

5 GALLON

WJ10005*
Inner: 1 Master: 1



FENDER COVER

- Heavy duty vinyl with foam backing
- Convenient built in tool pockets
- Fully sewn ribbed edge
- Size: 33" x 24"

W80583*
Inner: 1 Master: 12



POWER TOOLS & ACCESSORIES

600W GARAGE/SHOP HANDHELD BLOWER

- Amazing blowing power in a compact, easy to handle size
- 600W motor produces 75+ mph air flow and 16,000 max RPM
- Includes vacuum bag
- Specs - Voltage: 120 V AC, 60Hz, Rated Power: 600W, 5 AMPS, RPM: 16,000 max., Air Flow Rate: 75 CFM, Bag Capacity: 20 oz., Weight: 3.3 lbs., Noise Rating: 98 db(A)
- cETL listed 4008076

75 MPH AIR SPEED



WJ50063*
Inner: 1 Master: 8

700W VARIABLE SPEED HANDHELD SHOP BLOWER

- Amazing blowing power in a compact, easy to handle size
- Variable speed feature allows you to select just the right amount of power
- Two piece nozzle can be used at 9 inches or 18 inches
- Specs: 120 V AC, 60Hz, 700W, 5.8 AMPS, 17,000 max RPM, 90 MPH (145KPH) air speed, 100 CFM, 3.3 lbs (1.5Kg), 98 db(A)

90 MPH AIR SPEED

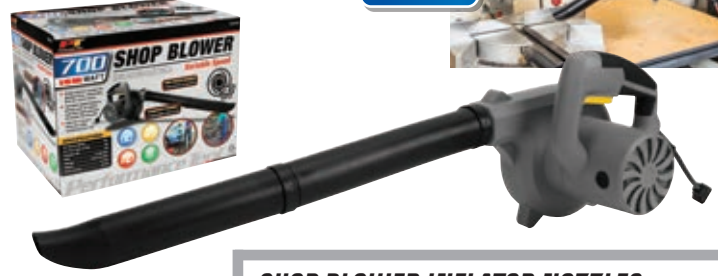

WJ50069*
Inner: 1 Master: 4

1/2" DR. IMPACT WRENCH

- 7.5a 110v AC motor
- 2700 RPM delivers 220 ft. lbs. max torque
- Rock trigger for quick change between forward and reverse
- Includes 11/16, 3/4, 13/16, and 7/8 in. impact sockets
- The 1/2 in. anvil with detent pin will securely hold your sockets when in use
- 6 ft. 2-pronged power cord
- CSA listed 216220



WJ50080*
Inner: 1 Master: 4

SHOP BLOWER INFLATOR NOZZLES

- 3 inflator nozzle attachments in 1 adapter
- Use to inflate large volume inflatables such as air mattresses, boats, pool toys, beach toys and more



ADD TO WJ50069 OR WJ50063

WJ50069A*
Inner: 12 Master: 48

19.2V CORDLESS DRILL

- 19.2 volt motor with forward / reverse switch
- 3/8" Chuck with 16+1 torque settings
- Comfortable rubber secure grip handle
- The integrated Nichia LED puts light right where it is needed
- 1200 mAh nickel cadmium Battery
- 3-5 hours, 120V-60Hz Charger
- 13 pc accessory set including: 6pc screwdriver bits: PH1, PH2, PZ1, PZ2, Slot 5, Slot 6, 6pc Drill bits - 1.5 2.5 3 4 5 6 and Magnetic bit holder
- cETL listed 4006774



WJ50092*
Inner: 1 Master: 5

90 DEG. IMPACT DRIVER ATTACHMENT

- Impact driver attachment lets you use 1/4" quick connect bits in tight spaces
- Die-cast gear housing and 3 sets of ball bearings for torque use up to 18 foot pounds
- Magnetic 1/4" hex adapter accepts standard drill and driver bits
- Works in forward or reverse

WJ9029*
Inner: 15 Master: 60



FOR USE IN TIGHT AREAS



INCLUDES 50 POPULAR BITS

3.6V LI-ION 2-IN-1 LIGHT/DRIVER

- This 3.6v Li-ion Cordless Screwdriver with 2 position swivel handle for a pistol grip or straight in-line for tight spaces
- 1/4" hex rapid change chuck features an adjustable 15+1 clutch to deliver the right amount of torque needed for the job
- LEDs are integrated into the front to illuminate your work area
- Specifications: Battery: 3.6v 1300mAh Lithium-Ion, RPM: 210, Chuck: 1/4" Hex, Max. Torque: 5ft. lbs, Charger: 110v 1.0A, Charging speed: 2 hour



WJ1562*
Inner: 1 Master: 8

FLASHLIGHT IN BASE

RIVET GUN DRILL ADAPTER

- This easy-to-use and install adapter converts any household corded or cordless drill into a power rivet gun
- Tough alloy steel nose and gearing works with aluminum or stainless-steel rivets to achieve professional results, even for a first-time user
- Works with rivet sizes: 3/32 in. (2.4mm), 1/8 in. (3.2mm), 5/32 in. (4.0mm), and 3/16 in. (4.8mm)

WJ9069*
Inner: 6 Master: 36



30 PC. TITANIUM DRILL BIT SET

- Drill bits are made from #4241 high speed steel (HSS) and coated with Titanium-nitride to reduce heat, keeping the 118-degree split cutting edge sharper, longer
- 4 of the most popular replacement bit sizes included: (3) 1/4", (7) 3/16", (10) 1/8", (10) 1/16" in
- Each drill bit size is held in a reusable, clear storage tube for convenience

WJ9009*

Inner: 12 Master: 48



253 PC. DRIVER & DRILL BIT SET

- This 253pc Driver and Drill bit set includes the most popular screwdriver bit styles and drill bits styles to handle most any job around the home and shop
- Titanium nitride coated drill bits, 1/8" and larger, are made from 4241 HSS with a 135 degree split point edge
- Included are 4 drill stops that work on all included drill bits to assure that hole are drilled to the specified depth and 1 hex key to lock them in place

WJ9080*

Inner: 1 Master: 6



3 PC. POWER TOOL BRUSH SET

- 3 pc kit contains 2" and 4" round flat brushes and one 3-1/2" dome shaped brush with medium stiffness polypropylene all-purpose bristles
- Standard 1/4" quick connect shaft molded to each brush for secure attachment to your power drill or driver (power tool not included)

WJ4991*

Inner: 1 Master: 32



Power tool not included.



6 PC. POWER TOOL ADAPTER SET

- Transform any drill into a power nut driver with these three impact grade steel square socket adapters: 1/4, 3/8, and 1/2"
- All 3 have built in detent balls to help hold your sockets in place during use
- 6" x 1/4" hex head flex extension bar has free spinning collar and detent ball to hold bits securely in place
- Magnetic 3" x 1/4" Hex drive extension holds onto fasteners, freeing up your hands in tight spaces

WJ9072*

Inner: 6 Master: 36



63 PC. TITANIUM DRILL BIT SET

- These titanium-nitride coated drill bits have a 118 degree cutting head and are made from #4241 High speed steel (HSS) which resist heat for durability

WJ9013*

Inner: 6 Master: 24



21 drill bits are sized from 1/16 to 3/8 in. : 1/16, 5/64, 3/32, 7/64, 1/8, 9/64, 5/32, 11/64, 3/16, 13/64, 7/32, 15/64, 1/4, 17/64, 9/32, 19/64, 5/16, 21/64, 11/32, 23/64, 3/8 in. Added are 41 extra bits of the 4 most popular sizes: (18) 1/16, (14) 1/8, (6) 3/16, (3) 1/4 in. which are packaged in 4 reusable storage tubes.

6 PC. 2" & 6" SOCKET ADAPTER SET

- Impact grade chrome vanadium steel with rust resistant black phosphate finish.
- Ball bearing ensures sockets are securely seated.
- 1/4" hex shank with 2" and 6" (50.8 mm and 152.4mm) overall lengths.
- Square drive sizes: 1/4, 3/8 and 1/2".

WJ9032*

Inner: 6 Master: 36

TRANSFORMS YOUR POWER DRILL INTO NUT/SOCKET DRIVER



10-WATT USB SOLDERING IRON

- High Output - reaches nearly 1000 degrees in about two minutes
- Versatile - operates from any powered USB outlet
- Compact, high quality, and ergonomic materials and design make it ideal for a wide range of applications
- 48-inch (120cm) power cord gives you plenty of distance to safely work with

WJ1999*

Inner: 6 Master: 24

USB POWERED



900W STEAM CLEANER

- Non-toxic - no dangerous chemicals, fumes or residues
- Clean grease, grime, dirt, soap scum, wrinkles, stains, bacteria, insects, doors, windows, floors
- Chemical-free solution for insects, bacteria and other household pests
- Includes 9 Accessories: flexible extension, round brush nozzle, 90° spray nozzle, long spray nozzle, wide nozzle, squeegee, fabric towel, funnel and measuring cup
- 10 ft. 2-pronged power cord

WJ50079*

Inner: 1 Master: 4



3-IN-1 BUTANE SOLDER IRON / HEAT GUN

- 3-in-1 butane tool functions as a soldering iron / heat gun / torch is ideal for working on electronics, shrink tubing, light gauge welding and more
- Self-ignition switch with safety lock, flame lock-on and built-in kick stand for hands-free operation
- Control temperature by sliding the flame adjustment lever from left and right: Soldering tip: up to 752°F (400°C), Hot blower tip: up to 932°F (500°C), Blow torch tip: up to 2372°F (1300°C)
- The clear 8.5 ml tank allows you to monitor exact butane levels and provides up to a 40 min run time



WJ2081*

Inner: 12 Master: 36

HANDY STORAGE CASE

CORDLESS SOLDERING IRON

- Reaches 365° F (185° C) immediately and cools down instantly
- Heats up to working temperature in under 15 seconds
- Maximum temperature of 1050° (585° C)
- Bright LED lights up your work area
- Includes 3g of solder (1.2mm diameter, 45cm L)

WJ2000*

Inner: 6 Master: 24



SEATS & CREEPERS

ROLLING STORAGE GARAGE SEAT

- Injection molded body reinforced with rectangular steel supports extending beyond the seat to provide maximum strength and stability
- Two large integrated side storage trays, oversized removable storage drawer, and three removable side trays
- Includes two movable trays that can go in any of the six slots on all three sides of the cart, designed to hold screwdrivers, wrenches, pliers, cans, nuts/bolts, and more

3 MOVABLE TRAYS



300 lb.
LOAD CAPACITY



ENDLESS CONFIGURATIONS WITH 7 TRAY LOCATIONS



W85035*
Inner: 1 Master: 1

ROLLING WORK SEAT

- Lightweight and durable composite seat with 4 swivel casters
- Storage trays and built-in storage compartment
- Great for working around wheels and brakes
- Size: 18 inches x 13.4 inches x 12.4 inches (457 x 340 x 315 mm)
- Weight capacity 330 lbs (150 Kg)

W85026*
Inner: 1 Master: 10

Sold in MASTER QTY.



3 DRAWER ROLLING MECHANICS SEAT

- Reinforced seat supports up to 350 lbs
- 3-drawer tool box with roller bearing slides
- Two folding tool trays with magnetic pads
- Vinyl padded seat cushion for maximum comfort and support
- Rear tray supports screwdrivers and pliers



W85025*
Inner: 1 Master: 1

40" 4-CASTER FOLDING COOL WEAVE CREEPER

- Heavy duty cool weave fabric with a steel power coated frame
- Ideal for automotive and garage applications
- Weather-resistant, lightweight, and provides extra comfort
- Folds for convenient transportation or storage

W85028*
Inner: 1 Master: 1



36" 6-CASTER CREEPER

- Six shielded swivel casters allow easy 360° movement and added stability
- Low profile design provides improved clearance
- Fully padded deck with cushion headrest
- Max 350lbs capacity (160Kg)
- Use replacement caster assembly Performance Tool model W85003

350 lb.
LOAD CAPACITY

LOW PROFILE DESIGN



QUICK ASSEMBLY

W85015*
Inner: 1 Master: 1

BAR STOOL W/SWIVEL SEAT

W85010*
Inner: 1 Master: 4

- 30" tall
- Durable, easy to clean, 14" round vinyl padded swiveling seat
- Sturdy chrome plated legs



PNEUMATIC ROLLING SHOP STOOL

- Pneumatic action adjusts seat height from 19 to 24 inches (480 to 610mm) quickly and easily
- Extra-wide powder coated 5-point frame and foot rest with durable crinkle finish
- Five hooded dual-caster swivel wheels for easy maneuverability
- Extra-thick 12.5 inch (318mm) diameter foam padded seat
- 300lb capacity (136 Kg)

W85033*
Inner: 1 Master: 4



ROLLING TOOL CADDY

- Provides easy mobile access to your tools while working under vehicles or in confined spaces.
- Keeps your tools organized within arm's reach so you don't have to search around for them or make multiple trips to your work bench or tool box.
- Large rolling tray is about 18 inches across and features 5 compartments; 2 large and 3 small.
- Integrated steel plate for magnetic tools such as a parts tray, work light or socket rail.

100 lb.
LOAD CAPACITY



W85032*
Inner: 1 Master: 6

Tools not included.



MULTI-PURPOSE WORKBENCH

- Folding design for compact storage
- Includes 4 bench dogs for odd shaped pieces
- Tabletop printed with grid, ruler and protractor for added convenience
- Includes tool storage rail
- 200 lb. safe working load
- Overall size: 23 7/8" x 25" x 31"



W54025*
Inner: 1 Master: 1

Tools not included.

ROLLER SUPPORT STAND

- Heavy gauge, rust resistant steel stand with polished steel roller
- Ideal for use with long workpieces to give ultimate support for accurate cuts
- Easy to grip height adjustment handle
- Wide, slip resistant base with rubber feet for added stability
- Folds flat for compact storage



W54010*
Inner: 1 Master: 4



FOLDING METAL SAWHORSE

- Durable powder coated steel construction.
- Padded top to protect work.
- Convenient steel carrying handle.
- Assembled size: 19 1/4 x 39 x 30 3/4 in. (489 x 991 x 781 mm).
- Folded size: 2 1/2 x 4 x 39 in. (64 x 101 x 991 mm).
- Capacity: 250 lb. (113.6 Kg)

W54035*
Inner: 1 Master: 4



250 lb.
LOAD CAPACITY

DIAMOND SHAPE ANTI-FATIGUE

ADDED COMFORT & LESS FATIGUE WHILE WORKING

- Add comfort and protection to any floor
- 3/8" Thick (10mm)
- 6 interlocking mats 2' x 2'. 24 sq. ft. in each pack
- Connect multiple packs for extended floor coverage
- Material: EVA Foam - Ethylene Vinyl Acetate

W88989*
Inner: 1 Master: 6



Sold in MASTER QTY.

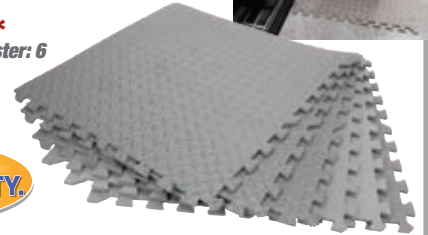

500 LB. SHOP STAND

- Designed to hold large parts such as bumpers, hoods, doors, fenders and glass.
- Portable, easy to adjust and stores flat.
- Thick foam padding protects painted parts and glass from being scratched.
- Specs: Capacity Rating: 500 lbs, Adjustable Height: 33 - 44 inches, Adjustable Width: 15 - 34 inches, Fixed Length: 40 inches

W54024*
Inner: 1 Master: 1



500 lb.
LOAD CAPACITY

14" WOOD HANDLE BENCH BRUSH

- Great for cleaning fine to medium size particles, such as dust, shavings and sawdust from smooth surfaces
- Durable natural wood handle contoured for comfort and control
- Black bristles and made of long-lasting polypropylene
- Bristled portion measures 7" long

W1232*
Inner: 4 Master: 24



5" MULTI-PURPOSE VISE

- Durable ductile iron construction provides superior strength for a long service life
- Positive-locking 360 degree swivel base allows jaws to be used at any position
- Two sets of jaws, 5 in. standard for square stock and pipe jaws for round stock
- 2-1/2 in. x 3-1/8 in. flat anvil surface for forming, or reforming metal parts
- Double lock down screws for secure positioning



DUCTILE IRON

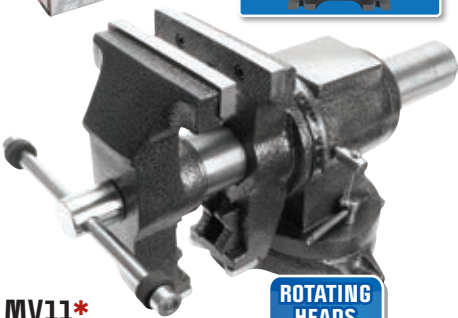

ROTATING HEADS

MV11*
Inner: 1 Master: 1

1080 PC. FASTENER ASSORTMENT

- Deluxe mix of fasteners to handle the needs of most projects
- Interlocking Lids keep the fasteners neatly organized without the ability to get mixed
- Unique stackable storage bins connect to each other for maximum portability
- This assortment offers more sizes to choose from, with 1080pc of 34 different sizes

W5263*
Inner: 1 Master: 4



REMOVABLE CHANNELS



STACK PACKS

2 PC. STACKABLE STORAGE CASE

- Unique stackable storage bins connect to each other for maximum portability
- Lids channels lock dividers in place keeping fasteners neatly organized without the ability to mixed
- Semi-transparent lid, comfortable carry handle, secure latches, and the ability to stack multiple cases

W5266*
Inner: 3 Master: 12



PERFECT FOR ORGANIZING SMALL ITEMS



LIFT EQUIPMENT

LIFT EQUIPMENT made of high-grade steel & engineered for quality and durability.



Floor Jacks
Bottle Jacks
Jack Stands
Engine Support & more

2 TON TROLLEY JACK & STAND

- Jack features 4,000 lb. capacity, maximum height 13", swivel casters for easy positioning
- Heavy duty steel lifting arm
- Tough enamel finish
- Jack stands feature ratchet style for easy adjustment, 10 3/8" to 16 3/8" range and 10 Lock safe settings



W1605*
Inner: 1 Master: 1

2 TON COMPACT TROLLEY JACK

- 4,000 lb capacity
- Maximum height 13"
- Swivel casters for easy positioning



W1606*
Inner: 1 Master: 1

2-1/2 TON GARAGE SERVICE JACK

- 5,000 lb. capacity
- Maximum height 19 1/4"
- Heavy duty construction 84 lb. GSW



W1612*
Inner: 1 Master: 1

2-1/4 TON TROLLEY JACK W/BLOW CASE

- A durable flanged steel frame powder coated and assembled with rust-resistant hardware
- Convenient carry handle and only 28 lbs.
- Lift Range: 5-3/8 to 15-1/4 in
- Load Capacity: 4,500 lb
- Meets or exceeds ASME PALD-2005



W1611*
Inner: 1 Master: 1

2 TON FLOOR JACK

- 4,000 lb. capacity
- Maximum height 15"
- Swivel casters for easy positioning



W1614*
Inner: 1 Master: 1

3 TON GARAGE JACK

- 6,000 lb. capacity
- Minimum Height 3-1/8 in
- Maximum Height 19-7/8 in
- Steel lifting saddle with 360 degree swivel



W1617*
Inner: 1 Master: 1

3 TON RAPID LIFT LOW PROFILE FLOOR JACK

- Dual piston rapid lift, raises most vehicles with just 3-1/2 pumps
- Precision-welded steel construction, with a powder-coated finish, and rust-resistant hardware
- Steel lifting saddle cleated for better load stability and is removable to adapt to other lifting accessories
- 45-1/2 in. long handle with a foam sleeve to protect the vehicle's side panel from damage
- Meets or exceeds ASME PALD-2014

W1626*
Inner: 1 Master: 1



LIFT RANGE:
3-1/4 TO 20 IN.

RAPID LIFT

3 TON

LOW PROFILE



2 TON LOW PROFILE FLOOR JACK

- Great for Cars and Light Duty Trucks
- Extended side flange for strength and durability
- Rubber saddle pad. Dual pistons for faster lift
- Lift range: 2-3/4 to 20" Load capacity: 4,000 lbs



W1642*
Inner: 1 Master: 1



3-1/4 IN. PROFILE



DUAL PISTON

SWIVEL CASTERS

PADDED HANDLE

3-1/2 TON LOW PROFILE FLOOR JACK

- 7,000 Lbs. Load Capacity
- Lift Range: 4" to 20 1/2"
- Swivel Casters
- Dual Pump
- Rubber Saddle Pad
- Durable Flanged Steel Frame
- Meets or Exceeds ASME PALD-2009



W1627*
Inner: 1 Master: 1

3-1/2 TON LOW PROFILE FLOOR JACK

- 3-1/2" to 20-1/2" Lift range
- Double-pump mechanism for quick lifting
- Rubber saddle pad included



W1645*
Inner: 1 Master: 1

TRANSMISSION ADAPTER

- Converts floor jacks into transmission jacks
- Fits all jacks with 1 5/32" removable saddle shaft
- Tilts forward and back and includes safety chain

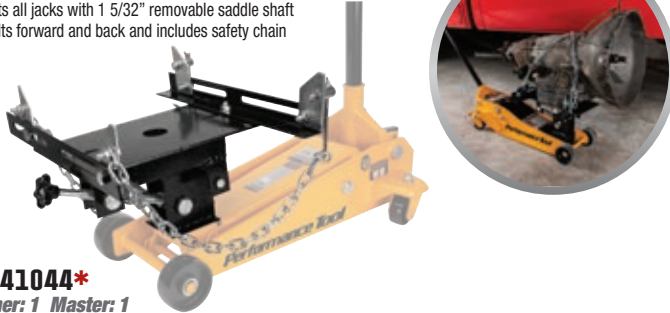

W41044*
Inner: 1 Master: 1

JACK STANDS (1 PAIR)

- Constructed of heavy duty steel for strength and durability
- Large saddle surface area provides better contact
- Ratchet style for easy adjustments



2 TON W41021*
Inner: 1 Master: 2
Lift Range: 10-3/8 to 16-3/8 in

3 TON W41022*
Inner: 1 Master: 2
Lift Range: 12 to 17-1/4 in

6 TON W41023*
Inner: 1 Master: 2
Lift Range: 15-1/2 to 23-1/2 in

SHORTY HYDRAULIC BOTTLE JACKS

- Heat treated critical stress areas ensure long life performance
- Grooved steel lifting saddle provides load stability
- Two piece sectional handle for easy assembly and storage
- Extension top screw adjusts to accommodate work height
- Folding carry handle
- Meets or exceeds ASME PALD-2009



12 TON W1643*
Inner: 1 Master: 2
Lift Range: 6-11/16 to 13 in

20 TON W1644*
Inner: 1 Master: 2
Lift Range: 7-1/4 to 13-3/4 in

2-1/2 TON GARAGE JACK

- A durable flanged steel frame powder coated and assembled with rust-resistant hardware
- Heavy-duty steel front wheels and ball-bearing swivel rear wheels provide easy positioning
- Convenient carry handle and only 28 lbs.
- Lift Range: 5-3/8 to 15-1/4 in
- Load Capacity: 5,000 lb
- Meets or exceeds ASME PALD-2005



W1640*
Inner: 1 Master: 1

1-1/2 TON SCISSOR JACK

- 3,000 Lbs. load Capacity
- Lift Range: 4" to 15"
- Oversized Base for added stability and support
- Compact size fits in truck



W1600*
Inner: 1 Master: 6



2 TON SUV SCISSOR JACK

- Sturdy steel construction with a 4,000 lb. load capacity
- Includes a ratchet wrench for tight spaces and the standard speed wrench
- Lifting range is 3.9 in. to 17.3 in., (9.9cm to 43.9cm), perfect for the taller Sport Utility Vehicles
- 15 in. x 4.75 in., (38.1cm x 12.1cm), oversized base for added stability and support



W1622*
Inner: 1 Master: 6



LIFT EQUIPMENT

HYDRAULIC BOTTLE JACKS

- Heat treated critical stress areas ensure long life performance
- Steel lifting saddle cleated for better load stability
- Two piece sectional handle for easy assembly and storage
- Oversize cast iron base for extra durability but still easily portable
- Meets or exceeds ASME PALD-2009

2 TON W1621*

Inner: 1 Master: 6

Lift Range: 7-1/8 to 13-1/2 in

4 TON W1623*

Inner: 1 Master: 6

Lift Range: 7-5/8 to 14-5/8 in

6 TON W1625*

Inner: 1 Master: 4

Lift Range: 8-1/2 to 16-1/4 in

8 TON W1628*

Inner: 1 Master: 4

Lift Range: 9 to 18 in

12 TON W1632*

Inner: 1 Master: 4

Lift Range: 9-1/4 to 18-1/2 in



20 TON W1633*

Inner: 1 Master: 2

Lift Range: 9-1/2 to 17-3/4 in

30 TON W1636*

Inner: 1 Master: 2

Lift Range: 11-1/4 to 18-1/4 in

50 TON W1637*

Inner: 1 Master: 1

Lift Range: 11-3/4 to 18-7/8 in



HEAVY DUTY
SHOP ESSENTIAL

2 TON FOLDING ENGINE CRANE

- 4,000 lb. capacity
- Adjustable boom with chain and hook
- Legs fold up for easy storage
- Patented design



4000 lb.
CAPACITY

3/4 TON ENGINE HOIST LEVELER

- Drop forged steel construction
- Heat treated chain and hooks
- Fully adjustable with threaded rod and 3 position chain mount holes



W41030*
Inner: 1 Master: 6

1250 LB. ENGINE STAND W/TRAY

- Stable 4 wheel design
- Head rotates 360 degrees and locks in 6 positions
- Sturdy metal parts tray
- Securely holds most foreign and domestic engine blocks
- Fully adjustable mounting head assembly



W41031*
Inner: 1 Master: 1

1,500 LB. MULTI-PURPOSE LIFT JACK

- 1,500 lb. capacity
- 4 1/2" to 16 1/2" lift range
- Two safety bolts ensure stability
- Three position locking levers
- Non-slip rubber foot pedal
- Easy to roll steel swivel casters

W41035*

Inner: 1 Master: 1



UNIVERSAL ENGINE LIFT PLATE

- Universal design fits more than 90% of common applications including Dominator manifolds
- Makes removing or installing engines with or without the transmission easy
- 1,000 lbs. maximum load
- Dominator is a registered trademark of Holley Performance Products, Inc

W41034*

Inner: 8 Master: 16

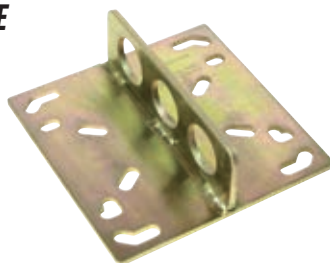

1 TON CHAIN HOIST

- Heavy duty construction
- heat treated bushings and bearings
- 8ft lift range



W4005DB*

Inner: 1 Master: 2



ENGINE LIFT CHAIN

- 1,000 lb. maximum load
- 34 in. chain, 37 in. overall length



W41032*

Inner: 6 Master: 24

SNOWMOBILE DOLLY

- 1500lb Capacity
- Heavy duty 2" casters
- Rubber covered top for secure moving

W41061*

Inner: 1 Master: 1



CROSSBAR DENT PULLER KIT

- Use to repair dents and dings in steel body panels without paint or fillers.
- A very economical, safe, and easy-to-use dent puller.
- Will not scratch your car's painted finish or clear coat.
- Includes a glue gun, with glue sticks, a crossbar with dent lifters, a dowel finishing tool, a bottle, and a plastic scraper for adhesive removal.
- Glue gun temperature range from 190 to 210 deg. C (374 to 410 deg. F)



NEW

W1008*
Inner: 1 Master: 8

6 PC. MINI PANEL REMOVAL TOOL SET

- Designed with an extra slim profile and unique shapes to easily remove small trim parts and panels.
- High-quality nylon material prevents scratches to painted surfaces and delicate panel surface.
- 6 different trim tools to make internal and external automotive removals easy.
- Interior: Remove interior trim, molding, dashboards, door panels, and more with ease.
- Exterior: Remove exterior door trim, molding, wheel covers, and other difficult-to-remove parts.
- Made from impact-resistant high-quality nylon



NEW

HIGH-QUALITY NYLON MATERIAL PREVENTS SCRATCHES

W83200*
Inner: 1 Master: 20

CAR WINDSHIELD REPAIR KITS

- Safe to use on all types of laminated windshields to minimize the appearance of damage and stop the spread of chips and cracks.
- Kit design works best on bullseye, half-moon, and star-shaped damage, up to 1-1/4 in. (31 mm), on most laminated windshield glass.
- Advanced resin repair fluid requires no mixing, cures in natural sunlight, and provides a professional quality repair.



NEW



STANDARD W3070*
Inner: 1 Master: 48

Included: Pedestal, Syringe, Advanced repair resin 2.5 ml, Pushpin, Razor blade, Adhesive discs (3), O-rings (3), Curing strips (5), instructions



DELUXE W3071*
Inner: 1 Master: 48

Included: Suction cup bracket, Repair resin 2.5 ml (2), Curing strips (5), Razor blade, Pushpin, and instructions

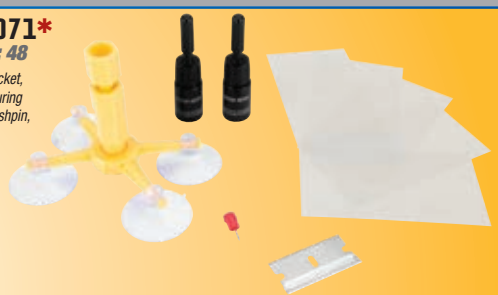

REFILL W3072*
Inner: 1 Master: 48

Included: Advanced resin repair fluid 2.5 ml (4), Curing strips (10), Razor blades (2)



4-1/2" SUCTION CUP DENT PULLERS

- Use for lifting, moving, pulling, and handling materials such as glass, mirrors, metal sheets, etc.
- Quick release and locking levers make it convenient to lock the suction in place and provide stability.
- The non-slip handles are made of thickened ABS plastic, not easily deformed or broken.
- Made with durable rubber suction pads and a heavy-duty plastic handle.
- Each of the suction plates is 11.68 cm. (4.6 in.) in diameter.



NEW



QUICK RELEASE LOCKING LEVERS

NON-SLIP HANDLES

USE FOR LIFTING, MOVING, PULLING & HANDLING MATERIALS

DUAL W1005*
Inner: 1 Master: 24
The maximum lifting Load capacity is 60 Kg. (132 lbs.)

TRIPLE W1006*
Inner: 1 Master: 12
The maximum lifting Load capacity is 120 kg. (264 lbs.)

8" PUMP VACUUM SUCTION CUP

- Use for moving or lifting flat stone, tiles, slabs, glass, or anything else with a smooth flat surface.
- The pump has a red line vacuum loss warning indicator, giving you notice if the vacuum is failing.
- Cup Size 20.32 cm. (8 in.) works in -20 deg. C to 60 deg. C (68 deg. F to 140 deg. F) temperatures.
- Maximum lifting capacity: 99.8 kg. (220 lbs.) horizontal and 81.7 kg. (180 lbs.) vertical



NEW

HOLDS VACUUM FOR 6 HOURS

180 lb. LIFTING CAPACITY



W1007*
Inner: 1 Master: 10

*California Residents Prop 65 warnings see page 48.

CARGO CONTROL



1" X 15' T-HANDLE TIE DOWN STRAPS

- 15-Foot long by 1-Inch wide polyester webbing
- 1000 Lbs. load limit, 3000 Lbs. break strength
- Open T-handle design allows for a better grip and faster tightening
- Durable cast aluminum construction with vinyl coated steel hooks



Sold in INNER QTY.

WJ1853*
Inner: 4 Master: 24

2" X 16' CAMO TIE DOWN STRAPS

- 16-Foot long by 2-Inch wide polyester webbing
- 3300 Lbs. load limit, 10000 Lbs. break strength
- Camouflage webbing blends into the natural outdoor environment
- Ratcheting mechanism tightens with vise-like gripping power



Sold in INNER QTY.

WJ1854*
Inner: 2 Master: 6

1" X 10' TIE DOWN STRAPS

- 10-Foot long by 1-Inch wide polyester webbing
- 600 Lbs. load limit, 1800 Lbs. break strength
- Constructed from durable cast aluminum construction, with ergonomic rubber grip
- Ratcheting mechanism tightens with vise-like gripping power



Sold in INNER QTY.

WJ1852*
Inner: 4 Master: 24

4 PK. 1" X 10' TIE DOWN STRAPS

- 10-Foot long by 1-Inch wide polyester webbing
- 300 Lbs. load limit, 900 Lbs. break strength
- Ratcheting mechanism tightens with vise-like gripping power
- Vinyl coated steel hooks



WJ1870*
Inner: 3 Master: 9

4 PK. 1" X 10' TIE DOWN STRAPS

- 10-Foot long by 1-Inch wide polyester webbing
- 500 Lbs. load limit, 1500 Lbs. break strength
- Constructed from durable cast aluminum construction, with padded comfort grip handle
- Padded release lever ensures ease of use
- Ratcheting mechanism tightens with vise-like gripping power



WJ1871*
Inner: 3 Master: 6

4 PK. 1" X 15' TIE DOWN STRAPS

- 15-Foot long by 1-Inch wide polyester webbing
- 1000 Lbs. load limit, 3000 Lbs. break strength
- Open T-handle design allows for a better grip and faster tightening
- Durable cast aluminum construction with vinyl coated steel hooks
- Padded release lever ensures ease of use
- Ratcheting mechanism tightens with vise-like gripping power



WJ1873*
Inner: 3 Master: 6

4 PK. 1" X 14' TIE DOWN STRAPS

- 14-Foot long by 1-Inch wide polyester webbing
- 1000 Lbs. load limit, 3000 Lbs. break strength
- Comfort-grip padded handle with vinyl coated steel hooks
- Padded release lever ensures ease of use
- Ratcheting mechanism tightens with vise-like gripping power



WJ1872*
Inner: 3 Master: 6

1 TON COMPACT CABLE POWER PULLER

- 2200-lb Compact Hand Power Puller
- Collapsible with carrying case for easy storage and portability
- 6 FT - 5mm Cable, Snap block converts 1,100 to 2,200 lb. pull
- Alloy Hooks with approved safety latches
- Removable handle with comfort grip for extra leverage



WJ4003*
Inner: 1 Master: 6

Applications: Stretching fences and wire, hoisting motors, shafts and gears, vehicle recovery, Farm/Ranch, Construction and more

EYEBOLT ANCHOR POINT

- Designed to provide a safe and secure tie down attachment point
- Fits most trucks with or without bed liners (may not fit all Dodge of Sierra/Silverado beds)
- Durable rust resistant chrome finish
- Installs easily in minutes, no drilling required
- 300 Lb. load limit, 900 Lb. break strength

W1881*
Inner: 6 Master: 60



Sold in INNER QTY.

2 PK. TRUCK BED ANCHOR POINTS

- Fits most trucks, with or without bed liners
- No drill installation
- Rubber base provides a secure tight fit
- 500 Lb. load limit, 1500 Lb. break strength

W1883*
Inner: 3 Master: 36



Sold in INNER QTY.



2 PK. ADHESIVE RUBBER SURE STEP

- Offers extra traction on trailer wheel wells, steps, ramps, or anywhere a non-skid surface is needed
- Strong adhesive backing adheres easily to any clean, smooth surface and prevents shifting or slipping
- UV and weather resistant rubber with diamond tread pattern

W1893*
Inner: 6 Master: 18

MEASURES 4 IN. X 15-1/2 IN.



Sold in INNER QTY.

RATCHETING CARGO BAR

- Adjustable cargo bar installs easily to prevent cargo from shifting in trucks, vans, and SUVs
- The ratcheting mechanism is used to add more tension for a tighter, stronger hold
- Cushioned rubber end pads to guard against slipping and scratches
- The steel bar adjusts from 40"-70"

W1447*
Inner: 5 Master: 10

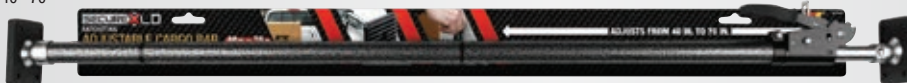

ADJUSTABLE FROM 40 TO 70 IN.



60" X 78" CARGO NET

- Durable plastic hooks fit over 1 inch (25mm) bars and are easy to hook to a truck's anchor points
- Multi-strand rubber core center for extra strength
- Holds up under extreme weather conditions
- Bungee material stretches to fit odd shaped loads
- 60 Inch by 78 Inch. Only use for light loads, Black

W1829*
Inner: 1 Master: 6

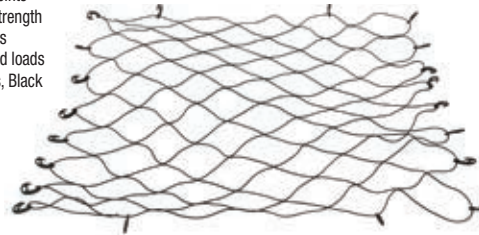

EASILY SECURE YOUR LOADS



20 PC. BUNGEE CORD ASSORTMENT

- Coated steel hooks with extra wide hook openings.
- Multi-strand rubber core center for extra strength.
- UV resistant color coded poly coating.
- Storage jar included.
- Assortment includes (2) 40-inch, (2) 30-inch, (4) 20-inch, (4) 15-inch, (6) mini and (2) canopy straps

W1890*
Inner: 1 Master: 9



HANDY STORAGE JAR INCLUDED

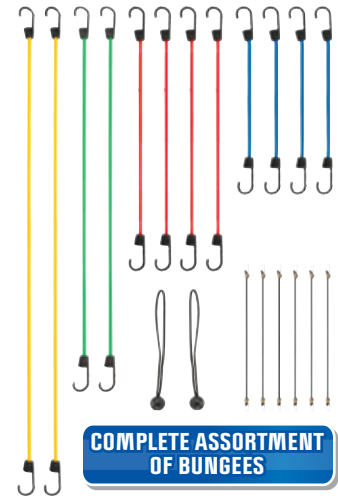

COMPLETE ASSORTMENT OF BUNGIES



FLAT CARABINER BUNGEE CORDS

- Combines the benefit of a flat bungee with the safety of a carabiner hook
- Flat bungee cord distributes load weight more evenly
- Anodized aluminum carabiners are corrosion resistant and connect more securely



5 PK. W1449*
Inner: 6 Master: 48
Includes: 12, 18, 24, 30 and 36 inch lengths



12 IN. W1451*
Inner: 12 Master: 96

18 IN. W1452*
Inner: 12 Master: 96

24 IN. W1453*
Inner: 6 Master: 72

30 IN. W1454*
Inner: 6 Master: 72

36 IN. W1455*
Inner: 6 Master: 48

48 IN. W1456*
Inner: 6 Master: 48



EPDM RUBBER TARP STRAPS

- Weather resistant EPDM material will not rot or lose elasticity after continuous exposure to the elements
- Versatile tarp strap for a variety of applications
- Zinc plated steel S-hooks

15 IN. W1811*
Inner: 6 Master: 96

21 IN. W1812*
Inner: 6 Master: 96

31 IN. W1813*
Inner: 6 Master: 96

41 IN. W1814*
Inner: 6 Master: 48



ZINC PLATED STEEL S-HOOKS



6 PC. W1891*
Inner: 1 Master: 9

- Includes (6) tarp straps, 2 each 15-inch, 21-inch, 31-inch black

HANDY STORAGE JAR INCLUDED



*California Residents Prop 65 warnings see page 48.

CARGO CONTROL

BLUE STANDARD DUTY TARPS

- Water, mildew and tear resistant
- Double water proof surfaces
- Double reinforced corners
- Rope sewn in along edges for added strength

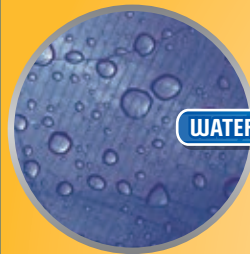

WATERPROOF



PERFECT FOR CAMPING



OR FOR USE AROUND THE HOUSE



4 MIL THICKNESS



5 FT. X 7 FT.

W6000*
Inner: 1 Master: 50

6 FT. X 8 FT.

W6002*
Inner: 1 Master: 40

8 FT. X 10 FT.

W6004*
Inner: 1 Master: 20

10 FT. X 12 FT.

W6006*
Inner: 1 Master: 15

10 FT. X 20 FT.

W6009*
Inner: 1 Master: 8

12 FT. X 16 FT.

W6011*
Inner: 1 Master: 10

16 FT. X 20 FT.

W6015*
Inner: 1 Master: 5

18 FT. X 24 FT.

W6020*
Inner: 1 Master: 5

20 FT. X 30 FT.

W6022*
Inner: 1 Master: 3

26 FT. X 40 FT.

W6025*
Inner: 1 Master: 2

REBAR STAKE KIT

Please contact your sales associate for pricing.

DISPLAY KIT W/SIGNS



SILVER HEAVY DUTY TARPS

- 10 mil Thickness
- Reinforced corners
- Rope sewn along edges for strength
- Rust resistant grommets

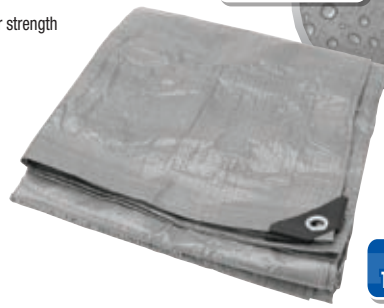

WATERPROOF

HEAVY DUTY 10 MIL THICKNESS

6 FT. X 8 FT.

W7002*
Inner: 1 Master: 20

8 FT. X 10 FT.

W7004*
Inner: 1 Master: 10

10 FT. X 12 FT.

W7006*
Inner: 1 Master: 8

REBAR GROUND ANCHOR STAKES

- Heavy duty all steel construction will not bend under pressure
- Sharp chisel point end helps to drive stake deep into the soil, even in rocky ground
- The rebar's ribbed exterior helps to hold stake firmly in place
- Durable painted black finish will inhibit rusting and make the stake less visible in its surroundings
- Welded on steel loop provides a strong and secure anchor point
- Use as ground anchors to secure tarps, tents, canopies, landscaping, bails, fencing, irrigation, soccer nets, inflatable outdoor yard decorations and more

18 IN. W9462*
Inner: 6 Master: 36

30 IN. W9463*
Inner: 6 Master: 18

48 IN. W9464*
Inner: 1 Master: 6

Sold in INNER QTY.

Sold in INNER QTY.

Sold in MASTER QTY.



4 PK. TARP CLIPS

- Multi-clip design features three holes for bungees, straps or tie downs, and friction fit slots for rope or paracord
- Designed to attach directly to covering for superior holding power
- Use to add an instant anchor point and better secure and cover your load
- Durable, high-impact nylon construction



W1892*
Inner: 12 Master: 72

WORKS WITH ALL OUR TARPS

100' REFLECTIVE PARACORD TYPE-IV 800 LB.

- Type-IV paracord has many uses from camping to landscaping or securing a load.
- 15+3-strand polyester/nylon core and 32 strand nylon sheath is abrasive, rot and mildew resistant.
- Black/orange cord is enhanced with light reflective strands woven in to increase visibility at night.
- The included plastic holder allows you to keep your rope tangle free and easy to store.
- Working Load Limit: 160 lb. (72.6 kg) / Break Strength: 800 lb. (249 kg).
- Cord measurements: 100 ft. x 0.125 in. (15 m x 4 mm).

NEW

W1996*

Inner: 12 Master: 24



HANDY CARRYING HANDLE

3/8" X 50' DIAMOND BRAID ROPE

- A great general-purpose rope with many uses; from camping to landscaping or securing a load
- Made from durable polypropylene material with braided construction provides added strength and flexibility
- Resistant to rot, mildew, oil, and abrasion making it suitable for outdoor use
- Rope is lightweight, easy to handle, and will even float on water
- Maximum weight capacity of 240 lbs. (109kg)

W1898*

Inner: 6 Master: 24

LIGHTWEIGHT & EASY TO HANDLE



Sold in INNER QTY.

DELUXE ROADSIDE ASSISTANCE KIT

- Zippered case with integrated reflective triangle.
- 8 ft. 10GA jumper cables for light autos.
- 2 ton 14 ft. tow rope (1,333 lbs. working load).
- Krypton flashlight (2 AA batteries included).
- Also included: pliers, 2 in 1 screwdriver, bungee cords, rain poncho, first aid kit, gloves, ice scraper, tire gauge, knife, cable ties and electrical tape.



W1555*

Inner: 1 Master: 6



EMERGENCY DOT WARNING TRIANGLE

- This D.O.T. approved warning triangle is ideal for unexpected roadside emergencies.
- Total weight of 2.9 pounds for stability in windy conditions.
- Measures 17.5" long / wide and 17.2" tall

DISPLAY W1499*

Inner: 1 Master: 4



3 PK. W1498*

Inner: 1 Master: 4



EMERGENCY AUTO SAFETY TOOL

- Bright LED flashlight
- 9 flashing red LED lights to alert others
- Seat belt cutter to quickly exit vehicle
- Glass breaker for emergency escapes
- Magnetic base holds the tool to any steel surface
- Powered by two AA batteries (not included)

W1553*

Inner: 6 Master: 48



EMERGENCY ESSENTIAL

LED SAFETY ROAD FLARES

- Make others aware of your vehicle even if the vehicle battery is dead
- Tough plastic construction is compact and lightweight
- 12 bright red LEDs last up to 50 hours
- Swivel hook and magnet on back for hands free use



SINGLE W2368*

Inner: 6 Master: 36

3 PK. W2343*

Inner: 4 Master: 32

REFLECTIVE TRIANGLE

- 14" x 12" orange and red reflective triangle
- Two 1/4" diameter mounting holes
- Great sign for farm vehicles, equipment, and a variety of obstructions to be seen from a far
- *May not meet specific state or federal requirements to be used on roads or job sites

W1496*

Inner: 1 Master: 50



ROADSIDE SAFETY TOOL KIT

- Useful automotive tools for a basic roadside repair
- Includes: jumper cables, pliers, screwdrivers, and more
- Contents: 8 ft Jumper Cables, Flashlight, Pencil Tire Gauge, Knit Gloves, Whistle, 10pc Fuse and Terminal Kit, 6 in. Slip Joint Pliers, #2 Philips Screwdriver, 1/4 in. Slotted Screwdriver
- 9 1/4 in. Drive Sockets: 1/4, 5/16, 3/8, 7/16 in., 4, 6, 8, 10, 12mm, 1/4 in. Drive Spinner Handle, 3/4 in. x 25 ft Electrical Tape
- 2AA Batteries included

W1556*

Inner: 1 Master: 10

EMERGENCY ESSENTIAL



*California Residents Prop 65 warnings see page 48.

CLEANING

4" MINI-PLUNGER W/CLEAR HANDLE

- Ideal compact plunger for your sink, toilet, shower, or tub use.
- 4 in. oversized flexible rubber cup delivers 2x the cleaning power as compared to the standard rubber plungers.
- 16 in. clear acrylic handle provides extended reach and is easy to keep clean.
- 17-1/2 in. total height stows easily under most sinks or cabinets

W6083*
Inner: 1 Master: 24

NEW



COMPACT DESIGN



17" ALUMINUM DUSTPAN

- Extra-large 17 in. aluminum dustpan.
- Lightweight, corrosion-resistant aluminum.
- Double riveted, looped tubular steel handle provides strength, rigidity, and easy storage.
- Dimensions: 16-1/2 in. (42cm) wide at mouth, 9 in. (23cm) depth, 2 in. (5cm) high at the back

WJ30*
Inner: 1 Master: 24



4 PC. MICROFIBER CLOTH SET

- Cleans without harsh chemicals, scratching or leaving lint.
- Lifts and traps dust to prevent scratches.
- Nonabrasive for delicate surfaces.
- Machine washable and dryable.
- Includes four cloths: green for washing, orange for dusting, yellow for polishing and blue for glass cleaning.
- Approximately 12 in. x 16 inches

W1474*
Inner: 6 Master: 48

Sold in INNER QTY.



24" SHOP BROOM W/STEEL HANDLE

- Soft 3-in. bristles for use on smooth to medium surfaces such as garage/shop floors, finished concrete, masonry and more.
- Durable polypropylene brush bristles.
- 60-in. powder-coated steel handle with universal aluminum ferrule and a handle with a hang hole.
- 15/16 in. (23.8mm) diameter steel handle.
- Threaded handle insert on both sides for even wear

WJ28*
Inner: 1 Master: 12

Sold in MASTER QTY.



PAIRS WELL WITH WJ30



2-HANDED HEAVY DUTY WIRE BRUSH

- Double-handed rubber grip handles are comfortable to use and allow for better control during use
- Ideal for you to apply extra pressure for tough jobs
- Brush size is 1.2 in. W x 9.75 in. L (30.5 x 247.7mm) with 5 rows across of carbon steel bristles
- Heavy-duty one-piece ABS frame for durability

W4989*
Inner: 6 Master: 24

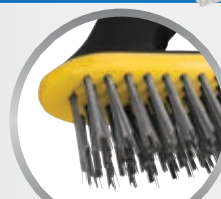

HEAVY DUTY WIRE BRISTLES

DOUBLE HANDED FOR PRECISE CONTROL



3-IN-1 TELESCOPING SNOW BRUSH

- Double ended tool with 10" brush/squeegee head, and 5-7/8" ice scraper
- Strong, lightweight aluminum twist lock telescoping handle for extended reach
- Durable ABS and polypropylene construction
- Soft foam grips for comfort and control
- Length: 32.5" - 43.5" (82.6-110.5cm); 7" brush (17.8cm) with 2.5" (6.4cm) bristles; 4" (10.2cm) scraper

W1465*
Inner: 1 Master: 12



24" SNOW BRUSH/ICE SCRAPER

- Ergonomic rubber handle provides positive grip in wet conditions
- Durable ABS and polypropylene construction holds up in the coldest of winters
- Scraper features built-in teeth for breaking up compacted ice
- Brush for removing snow and smaller bits of loose ice left over after scraping

W1461*
Inner: 12 Master: 24



40 PK. INDUSTRIAL MECHANIC WIPES

- The heaviest duty wipes you will ever find! Water saving, moisturizing, eco-friendly and a fresh lemon scent
- Powerful ingredients combine three different oils that clean the toughest of dirt, grease, grime, oil, paint, tar, sludge, silicone, adhesives and more
- Certified non-toxic, non-Prop 65 ingredients are safe, anti-bacterial, gentle on your hands, and still clean thoroughly

W1479*
Inner: 1 Master: 6



25 PK. RED SHOP TOWELS

- Machine washable.
- Soft all-cotton weave.
- Picks up dirt, grease and liquids.
- 13.75 in. x 13 inches

W1476*
Inner: 1 Master: 24



225 PC. COTTON CLEANING SWABS

- Industrial strength, low lint cotton swabs with excellent solvent holding capacity
- Strong, flexible bamboo handles will bend without breaking

W1470*
Inner: 6 Master: 48

Sizes included: (100) - 5mm x 7.6cm, (50) - 5mm x 15 cm, (25) - 12mm x 19.5 cm, (25) - 16mm x 21 cm and (25) - 20mm x 21.5 cm

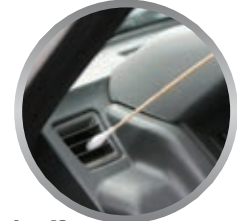

6 PC. DETAILING BRUSH SET

- Features contoured offset handles for better access, and sure-grip grooved PVC handles
- Nylon bristles for tile and grout, brass coated for dirt, and paint and steel bristles for everything else
- Includes six different brushes, three small 6-1/2 in. long and six medium 8-5/8 in. long

W4950*
Inner: 6 Master: 36



MULTI GRADE STEEL WOOL

- Versatile material, used for a variety of household, remodeling and construction tasks
- Smooth wood or rough up metal surfaces during paint prep
- Contains 4pcs #0 Fine, 4pcs #1 Medium, and 4pcs #3 Coarse

W1253*
Inner: 12 Master: 48



HEAVY DUTY 32 OZ. SPRAY BOTTLE

- Heavy duty chemical resistant sprayer bottle hold up to harsh cleaners and solvents
- High output fluid nozzle that can dispense large volumes down to a light mist
- A molded fingertip trigger helps reduce finger fatigue during rigorous use
- Full range Adjustable Nozzle for Fine Mist, Coarse Spray, and Jet Stream
- Handy Ounce and Milliliter scale molded into the side of the bottle for accurate measuring

W1473*
Inner: 12 Master: 24



285 PC. AUTOMOTIVE ELECTRICAL

- Great for use on automotive, marine, industrial and agricultural applications
- 2 part plastic case folds open 180° for easy access to both sides of kit

WJ5207*

Inner: 1 Master: 12



390 PC. CABLE CLIP ASSORTMENT

- Horseshoe shaped ABS clips with built-in high carbon steel nails
- Create smooth lines of cable running along your wall, baseboard, and even your ceiling
- Designed to fit most coaxial cables, phone lines, LAN/ ethernet wiring
- Six different sizes of clips in equal amounts of black and white

WJ2948*

Inner: 6 Master: 24



10 PK. 3/4" X 60' BLACK ELECTRICAL TAPE

- UL listed
- Multiple uses around shop, home & auto

WJ507*

Inner: 1 Master: 20



5 PK. 3/4" X 30' COLORED ELECTRICAL TAPE

- Multiple uses around shop, home, and auto
- Cold and weather-resistant
- 30' x 3/4"

WJ549*

Inner: 12 Master: 72



BLACK CABLE TIES

- Self-locking cable ties grip securely and provide a quick, inexpensive way to secure wires, hoses, fencing and more
- 100% QC inspections guarantee outstanding consistency, performance, and durability
- UV stable black nylon, CE lab certified, is approved for use in continuous exposure to outdoor sunlight

100 PC. 15 IN.

WJ2941*

Inner: 10 Master: 30

500 PC. 8 IN.

WJ2940*

Inner: 6 Master: 24



13-IN-1 ELECTRICIAN MULTI-TOOL

- All-in-one tool for basic electrical and other general purpose projects
- Spring loaded jaws with swivel lock
- 13 functions in 1 tool - 6 size wire strippers, long nose pliers, wire cutter, 3.0 & 4.5mm slotted & Phillips screwdrivers, coarse & fine files, serrated blade, can & bottle openers, knife & awl
- Strip and cut 10-18 AWG solid wire and stranded and 12-20 AWG stranded wire (0.8mm to 2.6mm)

WJ86506*

Inner: 12 Master: 48



250 PC. CABLE TIE ASSORTMENT

- 100% QC inspections guarantee outstanding consistency, performance, and durability
- UV stable carbon added to the nylon material of our white and black cable ties provide longer lifespan in sunlight compared to most other brands
- Assortment: 100pc - 4", 18lb cable ties in black and white / 50pc - 8", 40lb cable ties in white

WJ2942*

Inner: 10 Master: 100



25 PC. 8" ID MARKER CABLE TIES

- These ID marker cable ties have a 1 x 0.6" label area which allows you to mark wires or bundles for identification while securing them together at the same time
- 100% QC inspections guarantee outstanding performance and consistency
- UV stable black nylon, CE lab certified, is approved for use in continuous exposure to outdoor sunlight

WJ2945*

Inner: 10 Master: 100



50 PC. CABLE TIE MOUNTS

- Self-adhesive 1" square mounts allow you to attach cable ties directly to flat solid surfaces
- Adhesive backing works well for light duty applications but when extra holding capacity is needed use the 2 built-in holes to screw or rivet mount to surface
- Mounts have 4-way cable tie entry points and allows for horizontal or vertical securing

WJ2944*

Inner: 10 Master: 100



10 PC. 14" STAINLESS STEEL CABLE TIES

- Ties are made of 304 grade stainless steel which is high strength, nonflammable and offers excellent corrosion resistance for an uncompromising wear resistance
- Low profile design and fully rounded edges with smooth surfaces to protect cables from long term damage
- Measuring: 14 x 3/8 x 0.01" thick (360 x 10 x 0.25mm), Temperature range: -76 to 302F (-60 to 150 C), Tensile strength: 396lbs (180kg)

WJ2947*

Inner: 20 Master: 160



300 PC. CABLE TIE ASSORTMENT

- 100% QC inspections guarantee outstanding consistency, performance, and durability
- UV stable carbon added to the nylon material of our white and black cable ties provide longer lifespan in sunlight compared to most other brands
- 50pc of each color: red, green, blue, yellow, black, and white

WJ2943*

Inner: 10 Master: 100



40 PC. CLEAR PUSH PINS

- High quality clear plastic head with a 3/8 in. (9.5mm) sharp rust resistant steel pin
- Reusable storage case included
- Overall length: 1 in. (25.4mm)

WJ6080*

Inner: 24 Master: 144



SILVER HEAVY DUTY DUCT TAPE

- Heavy duty duct tape has thousands of uses around the home, garage or workshop
- Strong polyethylene backed, rubber base adhesive for a strong hold
- 2" wide, 50 yards long
- 17 mil thick

WJ503*

Inner: 1 Master: 24



MERCHANDISERS & DISPLAYS

Increase sales with easy product placement

28 PC. BIT SET IN MINI CASE

- Color coded bands for easy identification of bit type.
- Chrome vanadium construction with chrome nickel finish.
- Peg hook hanger tab can be pulled out for hanging or pushed flush into the case for compact storage.
- Contents: 2-3/8 in. (60 mm) Magnetic bit holder, (27) 1 in. (25 mm) bits: #0, #1, #2 (2), #3 Phillips; 3, 4, 5, 6, 7 mm Slotted; PZ0, PZ1, PZ2 (2), PZ3 Poz; T10, T15, T20, T25, T27, T30, T40 Star; 2, 3, 4, 5, 6 mm Hex

20245*

Inner: 12 Master: 48



BULK ITEM

50' PARACORD TYPE-III HIGH-VIZ REFLECTIVE

- Type III paracord has many uses from camping to landscaping or securing a load.
- 7-strand nylon core and 32-strand nylon sheath are rot and mildew resistant.
- High visibility color is enhanced with light reflective strands to increase visibility at night.
- Working load limit: 110 lb. (49.9 kg) / Break strength: 550 lb. (249 kg).
- Measurements: 50 ft. x 0.16 in. (15 m x 4 mm)



BULK ITEM

20246*
Inner: 6 Master: 144

MULTI-PURPOSE UTILITY SCISSORS

- Hardened stainless steel blades utilize an anti-slip serrated edge for making precise cuts.
- Notched blade is designed to cut cables up to 10 mm in diameter or used to strip insulation from wires.
- Measurements: 1-1/2 in. (28 mm) cutting blade and 6 in. (15.2 cm) total length

20247*
Inner: 12 Master: 72



BULK ITEM

ICE SCRAPER

- Heavy-duty scraping blade with ice ripping teeth
- Sturdy construction holds up in extreme weather
- 9 1/2" long with 4 1/4" wide blade

W9197*
Inner: 12 Master: 48



LED BIT DRIVER

- Three bright white LEDs illuminate your work area
- On-board bit storage
- Includes #1, #2 Phillips bits, and 3/16" and 1/4" slotted bits
- Requires 3AAA batteries (included)
- US Patent Number D693201

W9193*

Inner: 6 Master: 24



Sold in INNER QTY.

HIGH VISIBILITY LED BIT DRIVER

- Three bright white LEDs illuminate your work area
- On-board bit storage
- Includes #1, #2 Phillips bits, and 3/16" and 1/4" slotted bits
- US Patent Number D693201

W9205*
Inner: 12 Master: 48



Sold in INNER QTY.

LED BIT DRIVER W/ 30 BITS

- Improved design offer higher lumens, oversized handle and more bits
- Oversized ergonomic non-slip molded handle
- Features dual size bit driver for 1/4 inch and 5/32 inch precision bits stored in a convenient organizing case

W9208*

Inner: 12 Master: 48



Sold in INNER QTY.

SPINY BACK SCRATCHER

- Double-sided ABS spiny head provides two levels of itch relief
- Pointed side for precise application and rounded side for a gentler massaging effect
- Stainless steel telescoping sections provide just the right length
- Extends from 8 inches to 26 inches (20-66cm)

W9215*
Inner: 9 Master: 54



Sold in INNER QTY.

LI-ION LED CLIP FLEX LIGHT

- Low profile light bar provides 200+ lumens of warm white light
- Spring loaded clip features non-marring rubber padding and attaches to any object up to 1 inch (25mm) thick
- Specifications: 3 hour runtime, 3 hour charging time, 523450 1000mAh capacity lithium battery pack.

W9209*
Inner: 10 Master: 40



Sold in INNER QTY.

2 PK. MULTI-FUNCTION PENS

- First pen includes retractable ballpoint pen, precision Phillips/slotted screwdriver bit, touchscreen stylus, ruler, bubble level, bottle opener, and LED light
- Second pen features retractable ballpoint pen, precision Phillips/slotted screwdriver bit, touchscreen stylus, ruler, and bubble level

W9217*
Inner: 8 Master: 48



Sold in INNER QTY.

6 PC. SAE FOLDING NUT DRIVER SET

- Slim aluminum handle is durable, lightweight and easy to grip.
- Chrome vanadium steel construction.
- Sizes: 3/16, 1/4, 5/16, 11/32, 3/8, 7/16 inch

W9210*
Inner: 12 Master: 48



Sold in INNER QTY.

6 PC. METRIC FOLDING NUT DRIVER SET

- Slim aluminum handle is durable, lightweight and easy to grip.
- Chrome vanadium steel construction.
- Sizes: 5, 6, 8, 9, 10, 12 mm

W9211*
Inner: 12 Master: 48



Sold in INNER QTY.

TELESCOPING MAGNETIC PICKUP TOOL 8 LB.

- Heavy duty magnetic tip retrieves up to 8 lbs.
- Retriever extends over 24".
- Cushion grip handle.
- Handy pocket clip

W9101*
Inner: 12 Master: 72



*Sold in
INNER QTY.*

DIGITAL TIRE PRESSURE GAUGE

- Backlit display and convenient lighted tip.
- Triple function display P.S.I., BAR, and KPa.
- Auto off feature: Automatically shuts off in 30 seconds when not in use.
- Accurate to +/- 1 PSI.
- Requires (5) AG13 button cell batteries (included)

W9107*
Inner: 4 Master: 24



*Sold in
INNER QTY.*

STUBBY ADJUSTABLE WRENCH

- Stubby length is perfect for tight, confined areas.
- Wrench head features SAE and metric markings.
- Jaw opens to a full 1" capacity.
- Precision crafted thumb screw for smooth operation.

W9108*
Inner: 6 Master: 36



*Sold in
INNER QTY.*

1/4" & 3/8" DUAL DRIVE STUBBY RATCHET

- Features a dual 1/4" and 3/8" drive head.
- Compact stubby design for use in tight spaces.
- Features 72 gear teeth for speed and durability

W9113*
Inner: 6 Master: 36



*Sold in
INNER QTY.*

EXTENDED RAZOR SCRAPER

- Perfect at scraping labels & overspray off glass surfaces.
- Extended reach is easier to use, increases reach & leverage.
- Ergonomic grip w/broad hilt.
- Includes one standard razor blade

W9121*
Inner: 6 Master: 36



*Sold in
INNER QTY.*

9 PC. LONG ARM HEX KEY WRENCH SET

- Ball end on the long arm allows use at angles up to 25 deg.
- Slip resistant textured finish improves grip.
- Laser etched size markings for easy identification.
- Includes handy organizer.
- SAE sizes: 1/16, 5/64, 3/32, 1/8, 5/32, 3/16, 1/4, 5/16 & 3/8"

W9135*
Inner: 4 Master: 24



*Sold in
INNER QTY.*

9 PC. LONG ARM HEX KEY WRENCH SET

- Ball end on the long arm allows use at angles up to 25 deg.
- Slip resistant textured finish improves grip.
- Laser etched size markings for easy identification.
- Includes handy organizer.
- MET sizes: 1.5, 2, 2.5, 3, 4, 5, 6, 8 & 10 mm

W9136*
Inner: 4 Master: 24



*Sold in
INNER QTY.*

9 PC. LONG ARM STAR KEY SET

- Drilled tip on short arm allows use on tamper resistant security fasteners.
- Slip resistant textured finish improves grip.
- Laser etched size markings for easy identification.
- Includes handy organizer

W9137*
Inner: 4 Master: 24



*Sold in
INNER QTY.*

1-1/4" RIGID STAINLESS STEEL SCRAPER

- Perfect for removing gaskets, sealers & caked on materials.
- Rigid stainless steel blade w/ sharp chisel tip.
- Ergonomic grip w/broad hilt for greater comfort & control

W9181*
Inner: 6 Master: 36

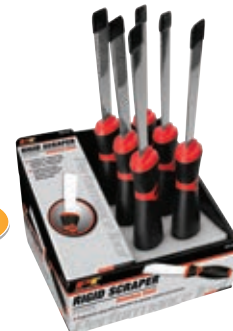

*Sold in
INNER QTY.*

ANGLED BACK SCRATCHER

- Angled hand portion provides more direct contact in those hard to reach spots.
- Includes magnet for picking up dropped nuts, bolts, staples and more.
- Anti-swivel groove to stabilize and prevent turning.
- Extends to over 20 inches

W9204*
Inner: 9 Master: 54



*Sold in
INNER QTY.*

1/4" DR. MINI RATCHET W/BITS

- Low profile oval head and compact size are great for tight work spaces
- 72 gear teeth for precise 5 degree sweep
- 1/4" hex with 1/4" drive socket adapter
- Includes 10pc bits and holder: Phillips #0, #1, #2, Slotted: 5/32", 3/16", 1/4", Square S1, S2, S3, and 1/4" adapter

W9127*
Inner: 4 Master: 24



*Sold in
INNER QTY.*

5 PC. HOOK & PICK SET

- Versatile tools ideal for pulling o-rings, seals, cotter pins, tape, brushes, separating wires, twine or thread and picking up small hard to grasp objects.
- Five styles give you a range of functions: curved hook, offset hook, 90 degree hook, straight pick, flat o-ring remover.
- Each coated pick is 3 in. long (75mm) and knurled for a positive grip or use by itself without the handle.

W9216*
Inner: 12 Master: 72



*Sold in
INNER QTY.*

6-IN-1 SCREWDRIVER

- Heavy duty high visibility handle.
- Positive grip double ended bit holder with 1/4" and 5/16" nut drivers.
- #1 and #2 Phillips.
- 1/4" and 3/16" Slotted

W9175*
Inner: 12 Master: 48



*Sold in
INNER QTY.*

TELESCOPING CLOTH DUSTER

- Innovative microfiber technology traps dust on contact.
- Removable 5-1/2 in. fabric duster is machine washable.
- Easily reaches high places and deep recesses.
- Extends from 11 in. to 30 inches.

W9202*
Inner: 12 Master: 96



*Sold in
INNER QTY.*

TWEEZERS WITH LED LIGHT

- Built-in LED light for better visibility of work area.
- Perforated non-slip surfaces.
- Uses three AG3/LR41 button cell batteries (included)

W9189*
Inner: 8 Master: 64



*Sold in
INNER QTY.*

MERCHANDISERS

MERCHANDISING STRIP W/S-HOOK

- Display hangable merchandise anywhere



EXPAND YOUR MERCHANDISING OPTIONS

W91001*
Inner: 50
Master: 200



ICE SCRAPER / SQUEEGEE

- 3 in 1 tool for ice breaking, scraping and wiping
- Low profile design stores anywhere
- High impact ABS construction

MERCH STRIP
W465*
Inner: 12
Master: 96

Sold in INNER QTY.



Sold in INNER QTY. **DISPLAY**
W9166*
Inner: 24
Master: 96



CARABINER W/MAGNETIC BASE

- Heavy duty rare earth magnets hold to any ferrous surface.
- Use to hang tools, keys, cords, ropes and more to any ferrous surface.
- Includes non-scratch liner.
- 45 lb. pull

W482*
Inner: 8 Master: 72

Sold in INNER QTY.



12-IN-1 PRECISION BIT DRIVER

- On-board storage for all six double ended bits
- Superior quality top grade chrome vanadium
- Comfortable impact resistant ABS handle
- Patented ratcheting mechanism delivers maximum torque
- Sizes: 3/32 & 9/64" Slotted, #00, #0, #1 & #2 Phillips, 1/8 & 3/32" Hex, T7, T8, T10 & T15 Star

W488*
Inner: 6 Master: 36

Sold in INNER QTY.



USB-C CHARGING CABLE

- 2-in-1 design features removable tethered cover for plugging into a standard USB or USB-C port.
- Universal compatibility supports all USB-C powered devices.
- Tangle-free braided nylon cable is poly coated to resist wear and tear and last 3X longer than standard cables.
- 60W Quick charging and data transfer up to 20V @ 3A.
- USB 2.0 supports data transfer at up to 480Mbps and simultaneous charging.
- 40 in. total length (1 m)

W492*
Inner: 8 Master: 64

Sold in INNER QTY.

NEW



7 PC. MICRO 1/4" BIT RATCHET SET

- Low-profile, compact design is great for tight work spaces
- 36 gear teeth for precise 10 degree sweep
- 1/4" hex with 1/4" drive socket adapter, and 5pc color coded CrV bits with holder: Phillips #0, #1, #2, Slotted 3/16, 1/4"

W490*
Inner: 12 Master: 144

Sold in INNER QTY.



44 PC. BUTTON CELL BATTERY PACK

- Includes: 12 AG13 (LR44) batteries, 6 AG3 (LR41) batteries, 12 CR2032 batteries, 6 CR2016 batteries, 4 CR2025 batteries and 4 CR1616 batteries (44 pieces total)

W483*
Inner: 8 Master: 48

Sold in INNER QTY.

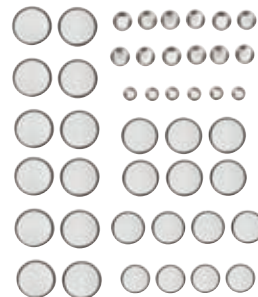

QUICK RELEASE BIT HOLDER

- Patented quick change bit mechanism is quick and easy to use
- One handed operation
- Magnetic insert bits in place and locking mechanism prevents pull out
- Use to quickly change between 1/4 inch hex drill bits, nutdrivers, driver bits and adapters
- 2-1/2 inch total length (63.5mm)

W489*
Inner: 12 Master: 72

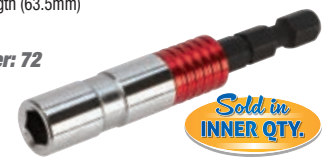

Sold in INNER QTY.

1/4" DR. MINI RATCHET W/BITS

- Low-profile oval head and compact size are great for tight work spaces.
- 72 gear teeth for precise 5 degree sweep.
- 1/4" hex with 1/4" drive socket adapter.
- Includes 10pc bits and holder: Phillips #0, #1, #2, Slotted 5/32, 3/16, 1/4", Square S1, S2, S3, 1/4" adapter

W475*
Inner: 6 Master: 48

Sold in INNER QTY.

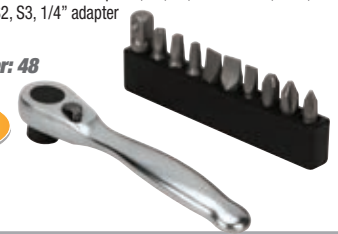

26 PC. PRECISION DRIVER PICKUP TOOL SET

- Two tools in one - precision ratcheting screwdriver and telescoping magnetic pickup tool.
- Reversible ratcheting mechanism features 40 gear teeth for minimal 9° rotation.
- Telescoping magnetic cap extends over 12 inches (30 cm) and features a flexible neck.
- Includes 4-1/2 in. (11.4 cm) extension and 24 precision bits with holders: (7) Phillips: #000, (2) #00, (2) #0, #1 & #2; (5) Slotted: 1/16, 5/64, 3/32, 1/8 & 5/32 in.; (5) SAE Hex bits: 1/16, 5/64, 3/32, 1/8 & 5/32 in.; (5) Star: T5, T6, T7, T8 & T9; (2) Trwing: 2 & 3 mm

W495*
Inner: 24 Master: 48

Sold in INNER QTY.



NEW

DUAL 12V USB/USB-C ADAPTER

- Charge two devices at the same time - one standard USB cord and one USB-C cord.
- Keep your electronic devices charging while on the go.
- Compatible with most USB charging devices and recharges most phones completely in 3-4 hours.
- Specifications: 12-24V input, 36W total output: 3A @ 5V, 2A @ 9V, 1.5A @ 12V

W493*
Inner: 8 Master: 64

NEW



USB & USB-C



4 PK. MINI PERMANENT MARKERS

- Permanent on most surfaces.
- Quick-drying.
- AP-certified nontoxic ink formula.
- Cap clip attaches easily to keychain or purse.

Sold in INNER QTY.

W477*
Inner: 8 Master: 48



7 PC. STUBBY PRECISION DRIVER

- 7-in-1 stubby screwdriver with Phillips, slotted and star bits.
- On-board storage keeps bits organized.
- Sizes: #0, #1 Phillips, 5/32, 1/8 in. slotted, T4, T5, T6 star

W476*
Inner: 12 Master: 48

Sold in INNER QTY.





We have a new collection of high-quality Northwest Trail knives. They are placed in a clear-view box, providing an improved view of the blade and handle. The clear-view box comes with a hanging tab and has a small footprint, measuring only 6-3/4" by 3-1/2" and with a 1" depth for multiple merchandising options.

DURBAN POCKET KNIFE

- 3.5 in. (90mm) blade length, 7.8 in. total length (199mm), 4.5 in. (114mm) closed length
- Polished 3CR13 stainless steel drop point blade, with liner lock
- Thumb stud, finger flipper, lanyard loop, and pocket clip
- Anodized aluminum handle with textured grip

W9381*

Inner: 6 Master: 48



KYOGA POCKET KNIFE

- 2.8 in. (70mm) blade length, 6.7 in. (170mm) total length, 4 in. (100mm) closed length
- 3CR13 stainless steel tanto blade with black electrophoresis coating
- Nylon and fiberglass composite grip, with thumb hole, pocket clip, lanyard loop, and liner lock

W9383*

Inner: 6 Master: 48



MASERU POCKET KNIFE

- 2.8 in. (70mm) blade length, 6.5 in. (165mm) total length, 3.7 in. (94mm) closed length
- 3CR13 stainless steel spearpoint blade with black oxide coating and inset rope cutting slots
- Lightweight, anodized aluminum handle, with liner lock, and pocket clip

W9382*

Inner: 6 Master: 48



BISINA POCKET KNIFE

- 2.5 in. (64mm) blade length, 6.5 in. (166mm) total length, 4.1 in. (105mm) closed length
- Partially serrated 3CR13 stainless steel clip point blade with black electrophoresis coating and thumb stud
- Anodized aluminum handle, with carabiner clip, and pocket clip

W9384*

Inner: 6 Master: 48



TABORA POCKET KNIFE

- 3.3 in. (85mm) blade length, 7.9 in. (200mm) total length, 4.6 in. (115mm) closed length
- 3CR13 stainless steel recurved blade with black electrophoresis coating and thumb stud
- Aluminum handle with blended black and olive anodized finish, liner lock, and pocket clip

W9386*

Inner: 6 Master: 48



BANTE POCKET KNIFE

- 3.3 in. (84mm) blade length, 8 in. (202mm) total length, 4.5 in. (115mm) closed length
- Partially serrated 3CR13 stainless steel drop point blade with black electrophoresis coating and thumb stud
- Push button blade release mechanism locks blade in open and closed position
- Combination of wood and anodized aluminum handle provide comfort, aesthetic appeal, and durability
- Integrated carabiner clip with spring-loaded catch and pocket clip

W9385*

Inner: 6 Master: 48



12-IN-1 OUTDOOR SURVIVAL KIT

- Adjustable beam flashlight with pocket clip, keychain light and plastic carabiner clip (Flashlight battery not included).
- Everything included stores compactly in a foam padded, water and shockproof storage box.
- Includes: Fire starter flint stick with striker and handle, pocket knife, multi-function card tool, cable saw, adjustable flashlight, carabiner clip, high-frequency whistle, emergency blanket, notebook, pen, plotting compass and foam-padded storage box.
- Case: 7.5 x 4.6 x 2.1 in. (190 x 118 x 55mm)

W9404*

Inner: 6 Master: 36



ESSENTIAL OUTDOORS KIT

4-IN-1 KNIFE SHARPENER

- Essential tool designed to sharpen a variety of tools including pocket knives, scissors, machetes, kitchen knives, multi-function tools, blades and more*.
- Features 4 slots: Slot 1 features a notched tungsten steel blade to sharpen scissors. Slots 2, 3 and 4 offer 3-stage knife sharpening for restoring your blade to a precision edge.
- Slot 2 has dual tungsten blades for grinding away dulled edges; Slot 3 has hardened emery rods to smooth and sharpen rough edges; Slot 4 has 4 ceramic rods to deliver a polished, sharp blade.

ALSO SHARPENS SCISSORS



W9405*

Inner: 8 Master: 32

4 PK. ASSISTED OPEN POCKET KNIFE SET

- Four different blade designs for a variety of needs, with color-coded hardware for easy identification
- Black stainless steel blade on each knife: Tanto blade (yellow), clip blade (red), leaf shape (green), partially serrated drop point (blue)
- Finger flipper and spring mechanism provide quick and easy assisted opening

SPRING ASSISTED

4 DIFFERENT BLADE STYLES



W9379*

Inner: 6 Master: 24

SAFETY GRIP KNIFE SHARPENER

- Safety handle provides positive easy grip while sharpening your knives.
- Tungsten carbide sharpening stones and high impact plastic handle.
- Great for sharpening knives and scissors.
- Includes one extra set of sharpening edges

W9402*

Inner: 12 Master: 72



*California Residents
Prop 65 warnings see page 48.

NEOPRENE PROTECTIVE WORK MAT

- Oversized mat provides a protected work space on your work bench, kitchen table or computer desk space
- Neoprene construction is chemical resistant to protect your work surface from cleaning solvents, oils and dirt
- Top thermo-fiber layer provides you with a firm but cushioned work surface while the 3mm thick rubber backing holds the mat in place and helps to protect your table
- Ruler with standard / metric measurements and several reference charts including SAE/Metric, fluid, and oil to gas ratios

W88977*

Inner: 12 Master: 24

**35-3/4 IN. X 16 IN.
(1/8 IN. THICK)**



Sold in
INNER QTY.

EXTRA THICK FOAM KNEELING PAD

- Lightweight, high density EVA foam delivers comfort, durability and a slip-resistant surface
- 1-1/2 in. (37mm) pad is 50% thicker than comparable pads delivering added protection
- Closed-cell design resists oil and water and retains its original shape
- Dimensions: 17-5/16 x 11-1/2 x 1-1/2 in. (44 x 29 x3.7 cm)

**HANDY CARRYING
HANDLE**



**17-5/16 IN. X 11-1/2 IN.
(1-1/2 IN. THICK)**

Sold in
MASTER QTY.

W88978*

Inner: 1 Master: 10

READING GLASSES

- Durable yet light weight, our stylish reading glasses combine visual clarity and outstanding performance
- Advanced frame material flexes but won't break, providing long lasting fit, comfort, and wearability
- Crystal clear acrylic lenses, treated with a hard protective coating to help reduce lens damage due to daily use and handling
- Interlocking sturdy hinge design ensures continual easy operation and a non-slip fit and feel for all-day use

Sold in
INNER QTY.

**ULTRA
FLEXIBLE**



+1.5 MAGNIFICATION

W1490*

Inner: 10 Master: 240

+2.0 MAGNIFICATION

W1491*

Inner: 10 Master: 240

+2.5 MAGNIFICATION

W1492*

Inner: 10 Master: 240



STEERING WHEEL CADDY DESK TOP

- Use the other side as a lunch table with a drink cut out and plenty of space to spread out your feast
- Designed to fit most steering wheels in seconds and can easily be stowed away when not in use
- Lightweight and super slim. Does not take up much space, just store in the back of the seat pocket
- Super strong blow molded plastic construction is easy to clean and will provide years of service
- Size: 28cm x 42cm x 2cm/11 inch x 16.5 inch x 0.79 inch

**DOUBLE
SIDED**



W1283*

Inner: 1 Master: 10

Sold in
MASTER QTY.

PLASTIC BOOT TRAY

- Perfect for muddy and wet boots and shoes
- Large enough to hold 3 pairs
- Made of 100% recycled materials



Sold in
MASTER QTY.

W89018*

Inner: 1 Master: 12

BOOT & SHOE BRUSH

- Wood blocks with heavy duty steel frame
- easily screwed down to any surface using the integrated tabs
- Heavy poly bristles for long life

W9451*

Inner: 1 Master: 6



**PERFECT COMPANION
TO W89018**

12 PK. MICROFIBER CLOTHS

- Clean without harsh chemicals, scratching or leaving lint
- Lifts and traps dust to prevent scratches
- Nonabrasive cleaning cloths for delicate surfaces
- Machine wash and dry



Sold in
MASTER QTY.

W1482*

Inner: 1 Master: 20



Wilmar, LLC

P.O. Box 88259 Tukwila, WA 98138

e-mail: tools@wilmarllc.com

1-800-426-1262 USA & Canada

***⚠WARNING: Cancer and Reproductive Harm -www.P65Warnings.ca.gov**



WS-2024-10

© Copyright 2024 Wilmar, LLC. This material is being furnished for the exclusive use of Wilmar, LLC customers and may only be used in connection with the sale of Wilmar®, Performance Tool®, PT POWER®, airTIGHT™, Northwest Trail®, Project Pro®, Mechanics Products® and ATAK® brand merchandise. Any other use is strictly prohibited. Illustrations and photographs are intended for reference only. Actual products may vary. On occasion, after printing of our catalogs, flyers or other sales aids is completed, the manufacturers may make changes and/or modifications to merchandise which will not be reflected in this literature. Accordingly, when ordering, please inquire of our sales representative as to any such changes or modifications which have been made following publication. Wilmar is not responsible for typographical, grammatical, numerical or hyphenation errors.